

32-Bit

Microcontroller

TC1724

32-Bit Single-Chip Microcontroller

SKYTECH

Data Sheet

V1.2 2014-06

Microcontrollers



Edition 2014-06

**Published by
Infineon Technologies AG
81726 Munich, Germany**

**© 2014 Infineon Technologies AG
All Rights Reserved.**

Legal Disclaimer

The information given in this document shall in no event be regarded as a guarantee of conditions or characteristics. With respect to any examples or hints given herein, any typical values stated herein and/or any information regarding the application of the device, Infineon Technologies hereby disclaims any and all warranties and liabilities of any kind, including without limitation, warranties of non-infringement of intellectual property rights of any third party.

Information

For further information on technology, delivery terms and conditions and prices, please contact the nearest Infineon Technologies Office (www.infineon.com).

Warnings

Due to technical requirements, components may contain dangerous substances. For information on the types in question, please contact the nearest Infineon Technologies Office.

Infineon Technologies components may be used in life-support devices or systems only with the express written approval of Infineon Technologies, if a failure of such components can reasonably be expected to cause the failure of that life-support device or system or to affect the safety or effectiveness of that device or system. Life support devices or systems are intended to be implanted in the human body or to support and/or maintain and sustain and/or protect human life. If they fail, it is reasonable to assume that the health of the user or other persons may be endangered.

32-Bit

Microcontroller

TC1724

32-Bit Single-Chip Microcontroller

SKYTECH

Data Sheet

V1.2 2014-06

Microcontrollers

Table of Contents

1	Summary of Features	1-1
2	System Overview of the TC1724	2-1
2.1	Block Diagrams	2-2
3	Pinning	3-1
4	Identification Registers	4-1
5	Electrical Parameters	5-1
5.1	General Parameters	5-1
5.1.1	Parameter Interpretation	5-1
5.1.2	Pad Driver and Pad Classes Summary	5-2
5.1.3	Absolute Maximum Ratings	5-3
5.1.4	Pin Reliability in Overload	5-5
5.1.5	Operating Conditions	5-7
5.2	DC Parameters	5-11
5.2.1	Input/Output Pins	5-11
5.2.2	Analog to Digital Converters (ADCx)	5-23
5.2.3	Fast Analog to Digital Converter (FADC)	5-34
5.2.4	Oscillator Pins	5-39
5.2.5	Power Supply Current	5-40
5.2.5.1	Calculating the 1.3 V Current Consumption	5-45
5.3	AC Parameters	5-47
5.3.1	Testing Waveforms	5-47
5.3.2	Power Sequencing 5V Supply Only	5-48
5.3.3	Power Sequencing 3.3V Supply Only	5-50
5.3.4	Power Sequencing all Voltages supplied from External	5-52
5.3.5	Power, Pad and Reset Timing	5-54
5.3.6	EVR Parameter	5-57
5.3.7	Phase Locked Loop (PLL)	5-60
5.3.8	ERAY Phase Locked Loop (ERAY_PLL)	5-62
5.3.9	JTAG Interface Timing	5-63
5.3.10	DAP Interface Timing	5-65
5.3.11	Peripheral Timings	5-67
5.3.11.1	Micro Link Interface (MLI) Timing	5-67
5.3.11.2	Micro Second Channel (MSC) Interface Timing	5-69
5.3.11.3	SSC Master/Slave Mode Timing	5-72
5.3.11.4	ERAY Interface Timing	5-75
5.4	Package and Reliability	5-77
5.4.1	Package Parameters	5-77
5.4.2	Package Outline	5-78

Table of Contents

5.4.3	Flash Memory Parameters	5-78
5.4.4	Quality Declarations	5-80
5.5	Revision History	5-81



SKYTECH

تهیه و توزیع قطعات الکترونیک

1 Summary of Features

The SAK-TC1724F-192F133HL / SAK-TC1724F-192F133HR has the following features:

- High-performance 32-bit super-scalar TriCore V1.3.1 CPU with 4-stage pipeline
 - Superior real-time performance
 - Strong bit handling
 - Fully integrated DSP capabilities
 - Single precision Floating Point Unit (FPU)
 - 133 MHz operation at full temperature range
- 32-bit Peripheral Control Processor with single cycle instruction (PCP2)
 - 8 Kbyte Parameter Memory (PRAM)
 - 24 Kbyte Code Memory (CMEM)
 - 133 MHz operation at full temperature range
- Multiple on-chip memories
 - 1.5 Mbyte Program Flash Memory (PFLASH) with ECC
 - 64 Kbyte Data Flash Memory (DFLASH) usable for EEPROM emulation
 - 120 Kbyte Data Memory (LDRAM)
 - Instruction Cache: up to 8Kbyte (ICACHE, configurable)
 - 24 Kbyte Code Scratchpad Memory (SPRAM)
 - Data Cache: up to 4 Kbyte (DCACHE, configurable)
 - 8 Kbyte Overlay Memory (OVRAM)
 - 16 Kbyte BootROM (BROM)
- 16-Channel DMA Controller
- Sophisticated interrupt system with 2×255 hardware priority arbitration levels serviced by CPU or PCP2
- High performing on-chip bus structure
 - 64-bit Local Memory Buses between CPU, Flash and Data Memory
 - 32-bit System Peripheral Bus (SPB) for on-chip peripheral and functional units
 - One bus bridge (LFI Bridge)
- Versatile On-chip Peripheral Units
 - Two Asynchronous/Synchronous Serial Channels (ASC) with baud rate generator, parity, framing and overrun error detection
 - Four High-Speed Synchronous Serial Channels (SSC) with programmable data length and shift direction
 - One serial Micro Second Bus interface (MSC) for serial port expansion to external power devices
 - One High-Speed Micro Link interface (MLI) for serial inter-processor communication
 - One MultiCAN Module with 3 CAN nodes and 64 free assignable message objects for high efficiency data handling via FIFO buffering and gateway data transfer
 - One FlexRay™ module with 2 channels (E-Ray).

Summary of Features

- One General Purpose Timer Array Module (GPTA) providing a powerful set of digital signal filtering and timer functionality to realize autonomous and complex Input/Output management
- Two Capture/Compare Unit 6 (CAPCOM6) kernels
- Two General Purpose Timer (GPT12) modules
- 28 analog input lines for ADC
 - 2 independent kernels (ADC0 and ADC1)
 - Analog supply voltage range from 3.3 V to 5 V (single supply)
 - Broken wire detection
- 2 different FADC input channels
 - channels with impedance control and overlaid with ADC1 inputs
 - Extreme fast conversion, 21 cycles of f_{FADC} clock
 - 10-bit A/D conversion (higher resolution can be achieved by averaging of consecutive conversions in digital data reduction filter)
- 95 digital general purpose I/O lines (GPIO)
- Digital I/O ports with 3.3 V capability
- On-chip debug support for OCDS Level 1 (CPU, PCP, DMA, On Chip Bus)
- Dedicated Emulation Device chip available (TC1724ED)
 - multi-core debugging, real time tracing, and calibration
 - four/five wire JTAG (IEEE 1149.1) or two wire DAP (Device Access Port) interface
- Power Management System
- Clock Generation Unit with PLL

The SKYTECH logo features the word "SKYTECH" in a large, bold, grey, sans-serif font. The letter 'Y' is stylized with a white arrow pointing upwards from its center.

تهیه و توزیع قطعات الکترونیک

Summary of Features

The SAK-TC1724N-192F133HR has the following features:

- High-performance 32-bit super-scalar TriCore V1.3.1 CPU with 4-stage pipeline
 - Superior real-time performance
 - Strong bit handling
 - Fully integrated DSP capabilities
 - Single precision Floating Point Unit (FPU)
 - 133 MHz operation at full temperature range
- 32-bit Peripheral Control Processor with single cycle instruction (PCP2)
 - 8 Kbyte Parameter Memory (PRAM)
 - 24 Kbyte Code Memory (CMEM)
 - 133 MHz operation at full temperature range
- Multiple on-chip memories
 - 1.5 Mbyte Program Flash Memory (PFLASH) with ECC
 - 64 Kbyte Data Flash Memory (DFLASH) usable for EEPROM emulation
 - 120 Kbyte Data Memory (LDRAM)
 - Instruction Cache: up to 8Kbyte (ICACHE, configurable)
 - 24 Kbyte Code Scratchpad Memory (SPRAM)
 - Data Cache: up to 4 Kbyte (DCACHE, configurable)
 - 8 Kbyte Overlay Memory (OVRAM)
 - 16 Kbyte BootROM (BROM)
- 16-Channel DMA Controller
- Sophisticated interrupt system with 2×255 hardware priority arbitration levels serviced by CPU or PCP2
- High performing on-chip bus structure
 - 64-bit Local Memory Buses between CPU, Flash and Data Memory
 - 32-bit System Peripheral Bus (SPB) for on-chip peripheral and functional units
 - One bus bridge (LFI Bridge)
- Versatile On-chip Peripheral Units
 - Two Asynchronous/Synchronous Serial Channels (ASC) with baud rate generator, parity, framing and overrun error detection
 - Four High-Speed Synchronous Serial Channels (SSC) with programmable data length and shift direction
 - One serial Micro Second Bus interface (MSC) for serial port expansion to external power devices
 - One High-Speed Micro Link interface (MLI) for serial inter-processor communication
 - One MultiCAN Module with 3 CAN nodes and 64 free assignable message objects for high efficiency data handling via FIFO buffering and gateway data transfer
 - One General Purpose Timer Array Module (GPTA) providing a powerful set of digital signal filtering and timer functionality to realize autonomous and complex Input/Output management
 - Two Capture/Compare Unit 6 (CAPCOM6) kernels

Summary of Features

- Two General Purpose Timer (GPT12) modules
- 28 analog input lines for ADC
 - 2 independent kernels (ADC0 and ADC1)
 - Analog supply voltage range from 3.3 V to 5 V (single supply)
- 2 different FADC input channels
 - channels with impedance control and overlaid with ADC1 inputs
 - Extreme fast conversion, 21 cycles of f_{FADC} clock
 - 10-bit A/D conversion (higher resolution can be achieved by averaging of consecutive conversions in digital data reduction filter)
- 95 digital general purpose I/O lines (GPIO)
- Digital I/O ports with 3.3 V capability
- On-chip debug support for OCDS Level 1 (CPU, PCP, DMA, On Chip Bus)
- Dedicated Emulation Device chip available (TC1724ED)
 - multi-core debugging, real time tracing, and calibration
 - four/five wire JTAG (IEEE 1149.1) or two wire DAP (Device Access Port) interface
- Power Management System
- Clock Generation Unit with PLL

The SKYTECH logo features the word "SKYTECH" in a large, bold, grey, sans-serif font. The letter 'Y' is stylized with a white arrow pointing upwards from its center. The logo is set against a background of a large, light purple, 3D-style geometric shape that resembles a stylized 'S' or a series of overlapping planes.

تهیه و توزیع قطعات الکترونیک

Summary of Features

The SAK-TC1724N-192F80HL / SAK-TC1724N-192F80HR has the following features:

- High-performance 32-bit super-scalar TriCore V1.3.1 CPU with 4-stage pipeline
 - Superior real-time performance
 - Strong bit handling
 - Fully integrated DSP capabilities
 - Single precision Floating Point Unit (FPU)
 - 80 MHz operation at full temperature range
- 32-bit Peripheral Control Processor with single cycle instruction (PCP2)
 - 8 Kbyte Parameter Memory (PRAM)
 - 24 Kbyte Code Memory (CMEM)
 - 80 MHz operation at full temperature range
- Multiple on-chip memories
 - 1.5 Mbyte Program Flash Memory (PFLASH) with ECC
 - 64 Kbyte Data Flash Memory (DFLASH) usable for EEPROM emulation
 - 120 Kbyte Data Memory (LDRAM)
 - Instruction Cache: up to 8Kbyte (ICACHE, configurable)
 - 24 Kbyte Code Scratchpad Memory (SPRAM)
 - Data Cache: up to 4 Kbyte (DCACHE, configurable)
 - 8 Kbyte Overlay Memory (OVRAM)
 - 16 Kbyte BootROM (BROM)
- 16-Channel DMA Controller
- Sophisticated interrupt system with 2×255 hardware priority arbitration levels serviced by CPU or PCP2
- High performing on-chip bus structure
 - 64-bit Local Memory Buses between CPU, Flash and Data Memory
 - 32-bit System Peripheral Bus (SPB) for on-chip peripheral and functional units
 - One bus bridge (LFI Bridge)
- Versatile On-chip Peripheral Units
 - Two Asynchronous/Synchronous Serial Channels (ASC) with baud rate generator, parity, framing and overrun error detection
 - Four High-Speed Synchronous Serial Channels (SSC) with programmable data length and shift direction
 - One serial Micro Second Bus interface (MSC) for serial port expansion to external power devices
 - One High-Speed Micro Link interface (MLI) for serial inter-processor communication
 - One MultiCAN Module with 3 CAN nodes and 64 free assignable message objects for high efficiency data handling via FIFO buffering and gateway data transfer
 - One General Purpose Timer Array Module (GPTA) providing a powerful set of digital signal filtering and timer functionality to realize autonomous and complex Input/Output management
 - Two Capture/Compare Unit 6 (CAPCOM6) kernels

Summary of Features

- Two General Purpose Timer (GPT12) modules
- 28 analog input lines for ADC
 - 2 independent kernels (ADC0 and ADC1)
 - Analog supply voltage range from 3.3 V to 5 V (single supply)
- 2 different FADC input channels
 - channels with impedance control and overlaid with ADC1 inputs
 - Extreme fast conversion, 21 cycles of f_{FADC} clock
 - 10-bit A/D conversion (higher resolution can be achieved by averaging of consecutive conversions in digital data reduction filter)
- 95 digital general purpose I/O lines (GPIO)
- Digital I/O ports with 3.3 V capability
- On-chip debug support for OCDS Level 1 (CPU, PCP, DMA, On Chip Bus)
- Dedicated Emulation Device chip available (TC1724ED)
 - multi-core debugging, real time tracing, and calibration
 - four/five wire JTAG (IEEE 1149.1) or two wire DAP (Device Access Port) interface
- Power Management System
- Clock Generation Unit with PLL

The SKYTECH logo features the word "SKYTECH" in a large, bold, grey, sans-serif font. The letter 'Y' is stylized with a white arrow pointing upwards from its center. The logo is set against a background of a large, light purple, 3D-style geometric shape that resembles a stylized 'S' or a series of overlapping planes.

تهیه و توزیع قطعات الکترونیک

Summary of Features

Ordering Information

The ordering code for Infineon microcontrollers provides an exact reference to the required product. This ordering code identifies:

- The derivative itself, i.e. its function set, the temperature range, and the supply voltage
- The package and the type of delivery.

For the available ordering codes for the TC1724 please refer to the “**Product Catalog Microcontrollers**”, which summarizes all available microcontroller variants.

This document describes the derivatives of the device. The **Table 1** enumerates these derivatives and summarizes the differences.

Table 1 TC1724 Derivative Synopsis

Derivative	Ambient Temperature Range (T _A)	CPU/PCP Freq.	Flash Size	ERAY	Wire Bond Material
SAK-TC1724F-192F133HL	-40°C to +125°C	133 MHz	1.5 MB	Yes	Au
SAK-TC1724F-192F133HR ¹⁾	-40°C to +125°C	133 MHz	1.5 MB	Yes	Cu
SAK-TC1724N-192F133HR	-40°C to +125°C	133 MHz	1.5 MB	No	Cu
SAK-TC1724N-192F80HL	-40°C to +125°C	80 MHz	1.5 MB	No	Au
SAK-TC1724N-192F80HR ²⁾	-40°C to +125°C	80 MHz	1.5 MB	No	Cu

1) This derivative has the same features as the SAK-TC1724F-192F133HL, except the wire-bonding material.

2) This derivative has the same features as the SAK-TC1724N-192F80HL, except the wire-bonding material.

تهیه و توزیع قطعات الکترونیک

2 System Overview of the TC1724

The TC1724 combines three powerful technologies within one silicon die, achieving new levels of power, speed, and economy for embedded applications:

- Reduced Instruction Set Computing (RISC) processor architecture
- Digital Signal Processing (DSP) operations and addressing modes
- On-chip memories and peripherals

DSP operations and addressing modes provide the computational power necessary to efficiently analyze complex real-world signals. The RISC load/store architecture provides high computational bandwidth with low system cost. On-chip memory and peripherals are designed to support even the most demanding high-bandwidth real-time embedded control-systems tasks.

Additional high-level features of the TC1724 include:

- Efficient memory organization: instruction and data scratch memories, caches
- Serial communication interfaces – flexible synchronous and asynchronous modes
- Peripheral Control Processor – standalone data operations and interrupt servicing
- DMA Controller – DMA operations and interrupt servicing
- General-purpose timers
- High-performance on-chip buses
- On-chip debugging and emulation facilities
- Flexible interconnections to external components
- Flexible power-management

The TC1724 is a high-performance microcontroller with TriCore CPU, program and data memories, buses, bus arbitration, an interrupt controller, a peripheral control processor and a DMA controller and several on-chip peripherals. The TC1724 is designed to meet the needs of the most demanding embedded control systems applications where the competing issues of price/performance, real-time responsiveness, computational power, data bandwidth, and power consumption are key design elements.

The TC1724 offers several versatile on-chip peripheral units such as serial controllers, timer units, CAPCOM6 and Analog-to-Digital converters. Within the TC1724, all these peripheral units are connected to the TriCore CPU/system via the Flexible Peripheral Interconnect (FPI) Bus and the Local Memory Bus (LMB). Several I/O lines on the TC1724 ports are reserved for these peripheral units to communicate with the external world.

System Overview of the TC1724

2.1 Block Diagrams

Figure 1 shows the block diagram of the SAK-TC1724F-192F133HL / SAK-TC1724F-192F133HR.

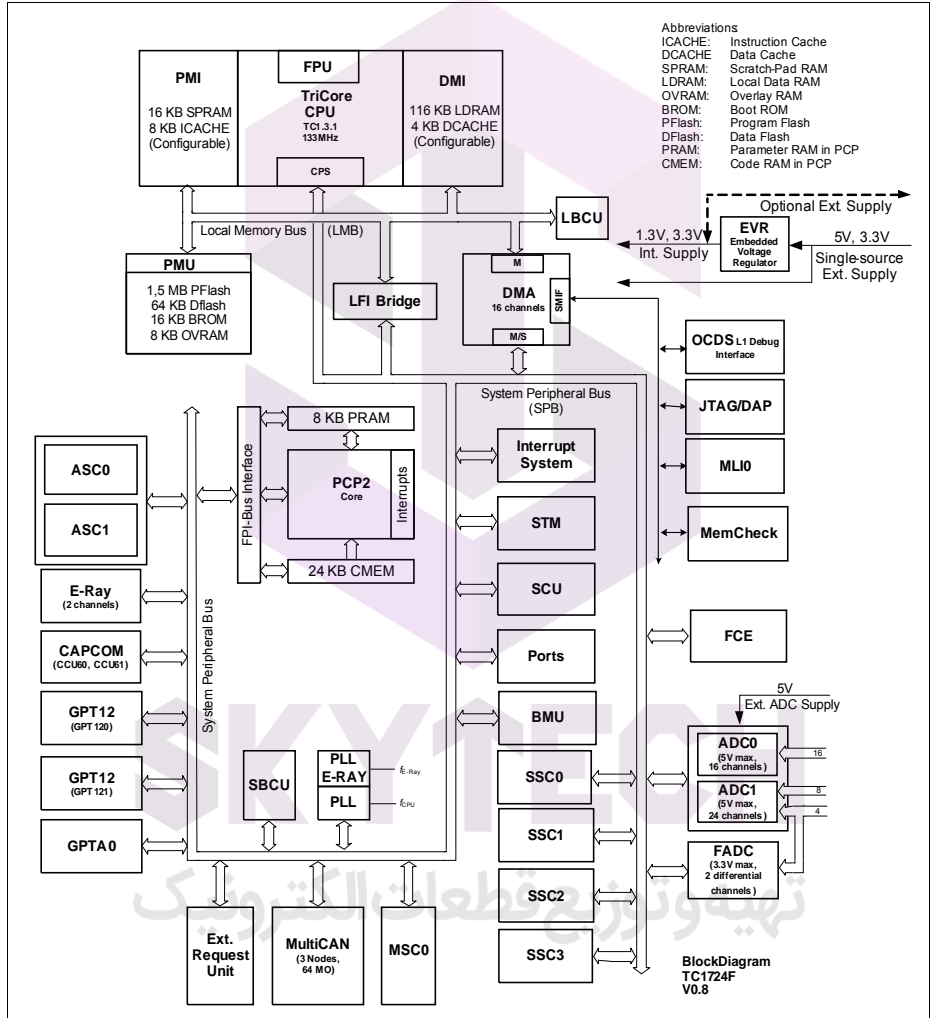

Figure 1 SAK-TC1724F-192F133HL / SAK-TC1724F-192F133HR Block Diagram

System Overview of the TC1724

Figure 2 shows the block diagram of the SAK-TC1724N-192F133HR.

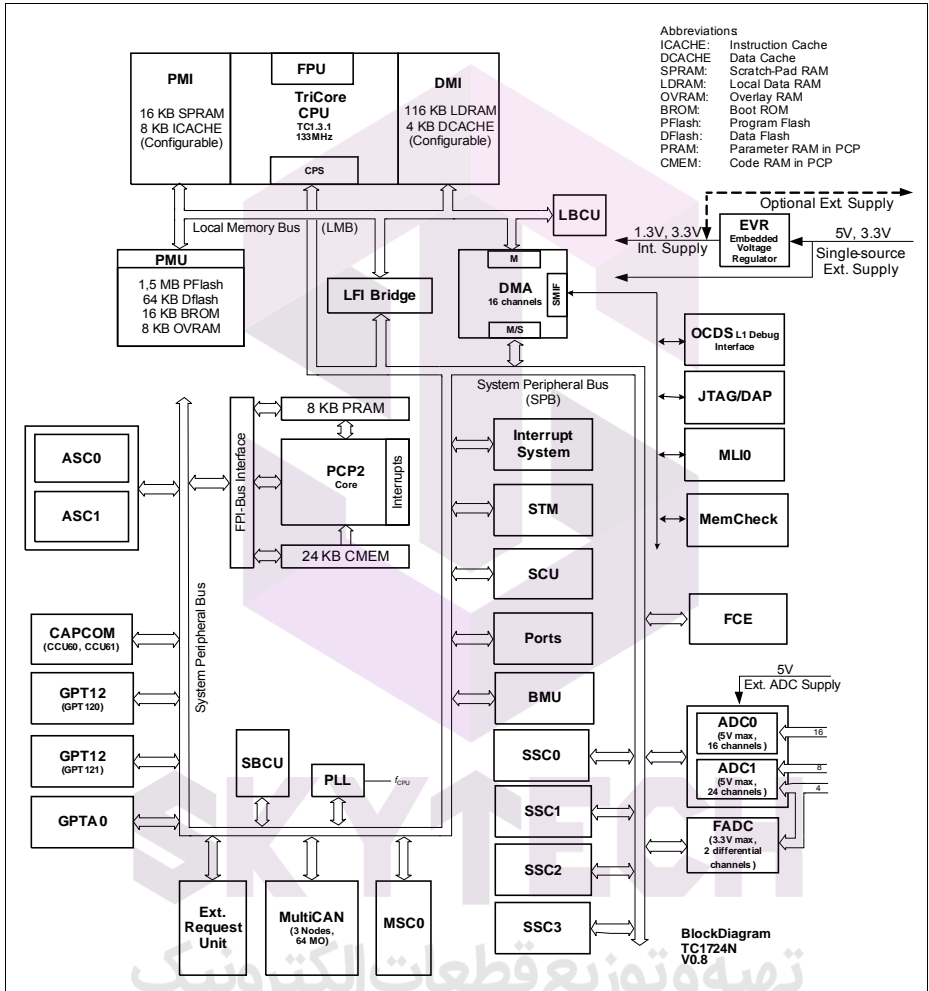

Figure 2 SAK-TC1724N-192F133HR Block Diagram

System Overview of the TC1724

Figure 3 shows the block diagram of the SAK-TC1724N-192F80HL / SAK-TC1724N-192F80HR.

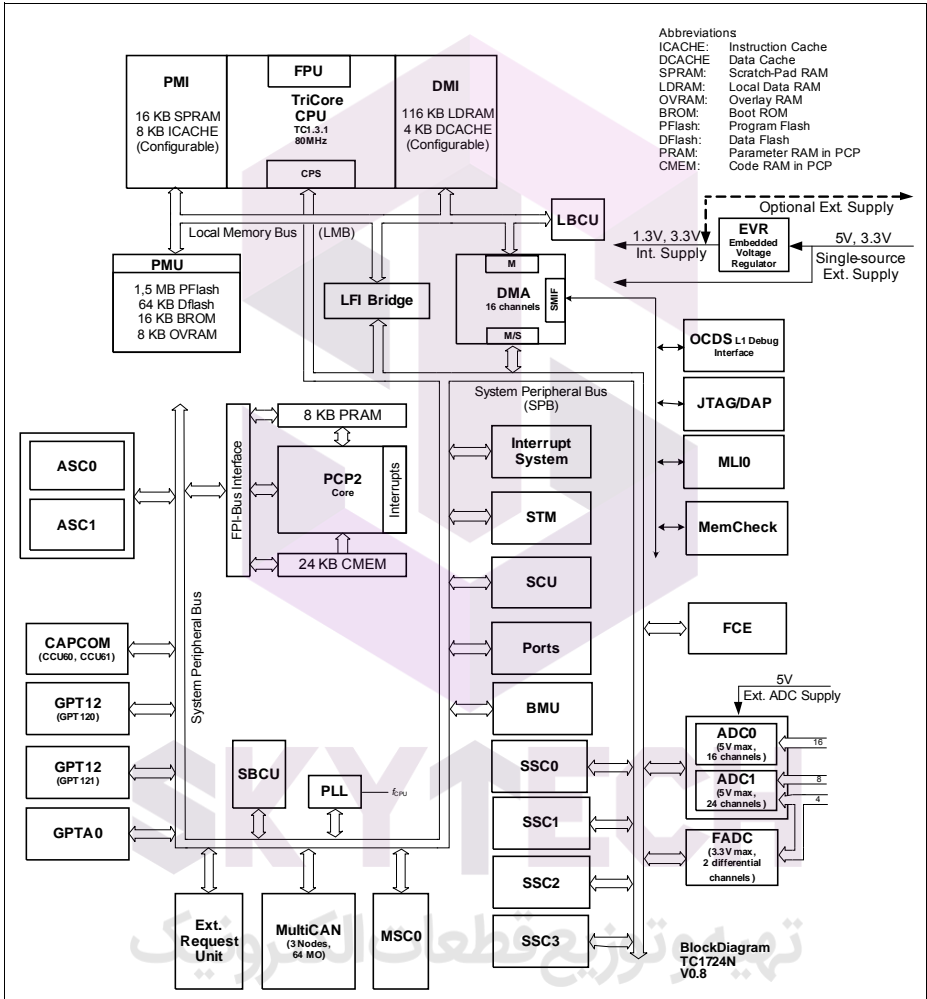

Figure 3 SAK-TC1724N-192F80HL / SAK-TC1724N-192F80HR Block Diagram

System Overview of the TC1724

Figure 4 shows the block diagram of the SAK-TC1724F-192F80HR.

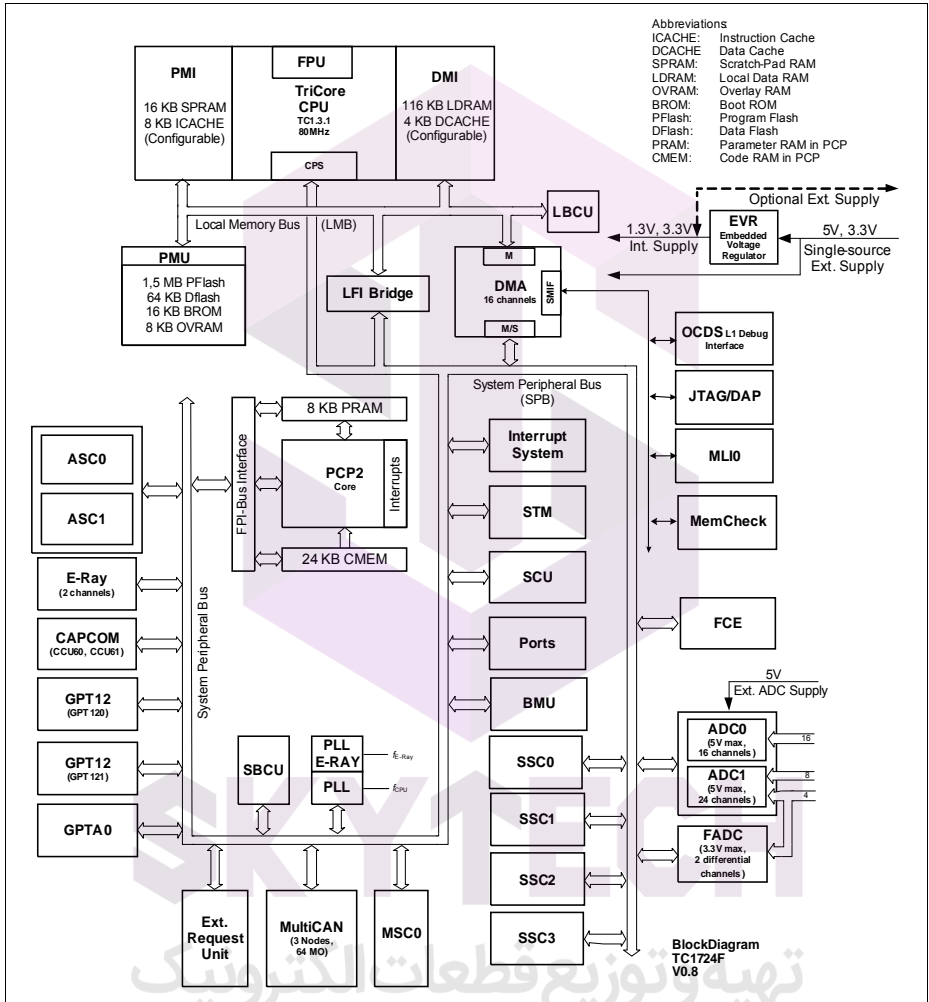

Figure 4 SAK-TC1724F-192F80HR Block Diagram

3 Pinning

Figure 5 shows the logic symbol for TC1724

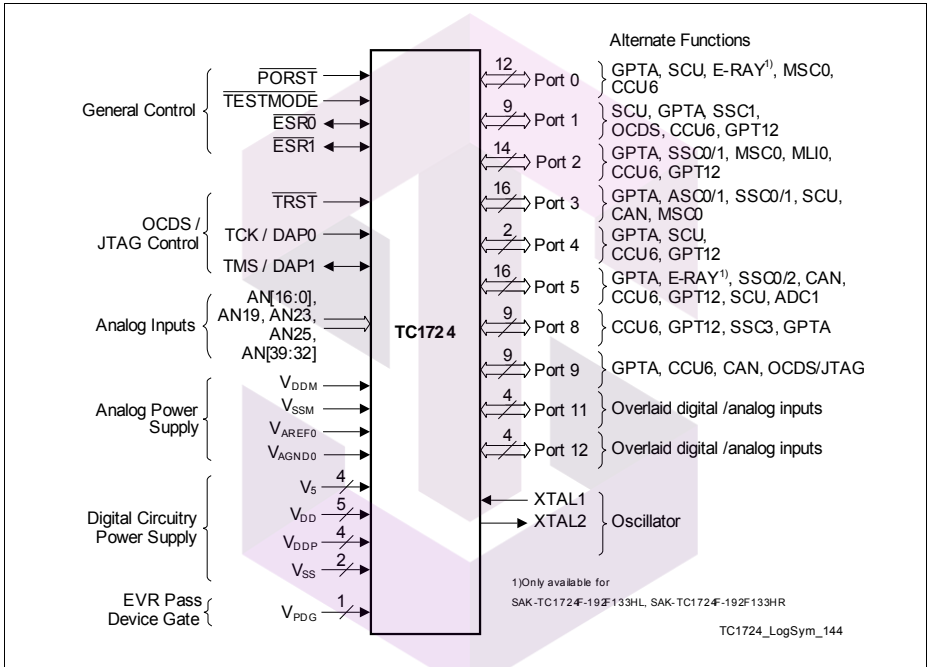

Figure 5 TC1724 Logic Symbol

SKYTECH

تهیه و توزیع قطعات الکترونیک

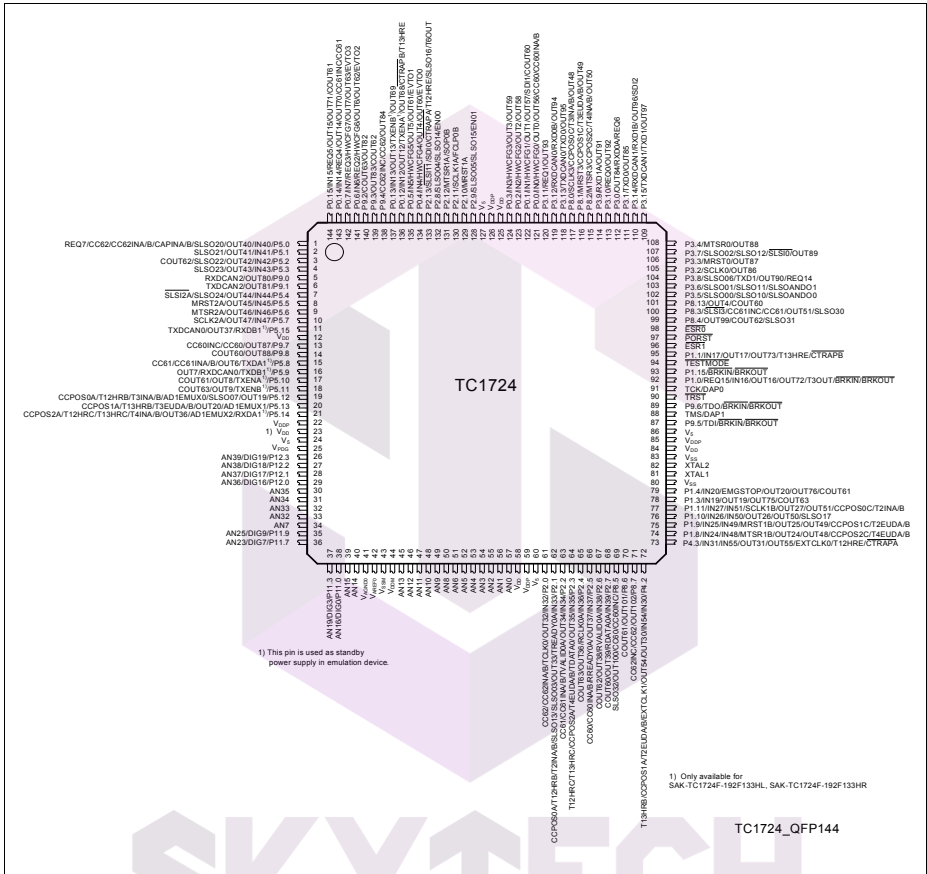

Figure 6 TC1724 Pinning for PG-LQFP-144-17 package

Table 3-1 Pin Definitions and Functions (PG-LQFP-144-17 package)

Pin	Symbol	Ctrl.	Type	Function
Port 0				

Table 3-1 Pin Definitions and Functions (PG-LQFP-144-17 package) (cont'd)

Pin	Symbol	Ctrl.	Type	Function
121	P0.0	I/O0	A1/ PU	Port 0 General Purpose I/O Line 0
	IN0	I		GPTA0 Input 0
	CCU60	I		CC60INA
	CCU61	I		CC60INB
	HWCFG0	I		Hardware Configuration Input 0
	OUT0	O1		GPTA0 Output 0
	OUT56	O2		GPTA0 Output 56
	CCU60	O3		CC60
122	P0.1	I/O0	A1/ PU	Port 0 General Purpose I/O Line 1
	IN1	I		GPTA0 Input 1
	SDI1	I		MSC0 Serial Data Input 1
	HWCFG1	I		Hardware Configuration Input 1
	OUT1	O1		GPTA0 Output 1
	OUT57	O2		GPTA0 Output 57
	CCU60	O3		COUT60
123	P0.2	I/O0	A1/ PU	Port 0 General Purpose I/O Line 2
	IN2	I		GPTA0 Input 2
	HWCFG2	I		Hardware Configuration Input 2
	OUT2	O1		GPTA0 Output 2
	OUT58	O2		GPTA0 Output 58
	Reserved	O3		-
124	P0.3	I/O0	A1+/ PU	Port 0 General Purpose I/O Line 3
	IN3	I		GPTA0 Input 3
	HWCFG3	I		Hardware Configuration Input 3
	OUT3	O1		GPTA0 Output 3
	OUT59	O2		GPTA0 Output 59
	Reserved	O3		-

Table 3-1 Pin Definitions and Functions (PG-LQFP-144-17 package) (cont'd)

Pin	Symbol	Ctrl.	Type	Function
134	P0.4	I/O0	A1/ PD	Port 0 General Purpose I/O Line 4
	IN4	I		GPTA0 Input 4
	HWCFG4	I		Hardware Configuration Input 4
	OUT4	O1		GPTA0 Output 4
	OUT60	O2		GPTA0 Output 60
	EVT00	O3		MCDS event output 0
135	P0.5	I/O0	A1/ PD	Port 0 General Purpose I/O Line 5
	IN5	I		GPTA0 Input 5
	HWCFG5	I		Hardware Configuration Input 5
	OUT5	O1		GPTA0 Output 5
	OUT61	O2		GPTA0 Output 61
	EVT01	O3		MCDS event output 1
141	P0.6	I/O0	A1/ PU	Port 0 General Purpose I/O Line 6
	IN6	I		GPTA0 Input 6
	HWCFG6	I		Hardware Configuration Input 6
	REQ2	I		External Request Input 2
	OUT6	O1		GPTA0 Output 6
	OUT62	O2		GPTA0 Output 62
142	P0.7	I/O0	A1/ PU	Port 0 General Purpose I/O Line 7
	IN7	I		GPTA0 Input 7
	HWCFG7	I		Hardware Configuration Input 7
	REQ3	I		External Request Input 3
	OUT7	O1		GPTA0 Output 7
	OUT63	O2		GPTA0 Output 63
	EVT03	O3		MCDS event output 3

Table 3-1 Pin Definitions and Functions (PG-LQFP-144-17 package) (cont'd)

Pin	Symbol	Ctrl.	Type	Function
136	P0.12	I/O0	A2/ PU	Port 0 General Purpose I/O Line 12
	IN12	I		GPTA0 Input 12
	CCU60	I		CTRAPB
	CCU61	I		T13HRE
	OUT12	O1		GPTA0 Output 12
	OUT68	O2		GPTA0 Output 68
	TXENA	O3		E-Ray Channel A transmit Data Output enable¹⁾
137	P0.13	I/O0	A2/ PU	Port 0 General Purpose I/O Line 13
	IN13	I		GPTA0 Input 13
	OUT13	O1		GPTA0 Output 13
	OUT69	O2		GPTA0 Output 69
	TXENB	O3		E-Ray Channel B transmit Data Output enable¹⁾
143	P0.14	I/O0	A1+/ PU	Port 0 General Purpose I/O Line 14
	IN14	I		GPTA0 Input 14
	REQ4	I		External Request Input 4
	CCU61	I		CC61INC
	OUT14	O1		GPTA0 Output 14
	OUT70	O2		GPTA0 Output 70
	CCU60	O3		CC61
144	P0.15	I/O0	A1+/ PU	Port 0 General Purpose I/O Line 15
	IN15	I		GPTA0 Input 15
	REQ5	I		External Request Input 5
	OUT15	O1		GPTA0 Output 15
	OUT71	O2		GPTA0 Output 71
	CCU60	O3		COU61

Port 1

Table 3-1 Pin Definitions and Functions (PG-LQFP-144-17 package) (cont'd)

Pin	Symbol	Ctrl.	Type	Function
92	P1.0	I/O0	A2/ PU	Port 1 General Purpose I/O Line 0
	REQ15	I		External Request Input 15
	IN16	I		GPTA0 Input 16
	BRKIN	I		Break Input
	OUT16	O1		GPTA0 Output 16
	OUT72	O2		GPTA0 Output 72
	GPT120	O3		T3OUT
	BRKOUT	O		Break Output (controlled by OCDS module)
95	P1.1	I/O0	A1/ PU	Port 1 General Purpose I/O Line 1
	IN17	I		GPTA0 Input 17
	CCU60	I		T13HRE
	CCU61	I		CTRABP
	OUT17	O1		GPTA0 Output 17
	OUT73	O2		GPTA0 Output 73
	Reserved	O3		-
	78	P1.3		I/O0
IN19		I	GPTA0 Input 19	
OUT19		O1	GPTA0 Output 19	
OUT75		O2	GPTA0 Output 75	
CCU61		O3	COUT63	
79	P1.4	I/O0	A1/ PU	Port 1 General Purpose I/O Line 4
	IN20	I		GPTA0 Input 20
	EMGSTOP	I		Emergency Stop Input
	OUT20	O1		GPTA0 Output 20
	OUT76	O2		GPTA0 Output 76
	CCU61	O3		COUT61

Table 3-1 Pin Definitions and Functions (PG-LQFP-144-17 package) (cont'd)

Pin	Symbol	Ctrl.	Type	Function
74	P1.8	I/O0	A1+/ PU	Port 1 General Purpose I/O Line 8
	IN24	I		GPTA0 Input 24
	IN48	I		GPTA0 Input 48
	MTSR1B	I		SSC1 Slave Receive Input B (Slave Mode)
	CCU61	I		CCPOS2C
	GPT120	I		T4EUDB
	GPT121	I		T4EUDA
	OUT24	O1		GPTA0 Output 24
	OUT48	O2		GPTA0 Output 48
	MTSR1B	O3		SSC1 Master Transmit Output B (Master Mode)
75	P1.9	I/O0	A1+/ PU	Port 1 General Purpose I/O Line 9
	IN25	I		GPTA0 Input 25
	IN49	I		GPTA0 Input 49
	MRST1B	I		SSC1 Master Receive Input B (Master Mode)
	CCU61	I		CCPOS1C
	GPT120	I		T2EUDB
	GPT121	I		T2EUDA
	OUT25	O1		GPTA0 Output 25
	OUT49	O2		GPTA0 Output 49
	MRST1B	O3		SSC1 Slave Transmit Output B (Slave Mode)
76	P1.10	I/O0	A1+/ PU	Port 1 General Purpose I/O Line 10
	IN26	I		GPTA0 Input 26
	IN50	I		GPTA0 Input 50
	OUT26	O1		GPTA0 Output 26
	OUT50	O2		GPTA0 Output 50
	SLSO17	O3		SSC1 Slave Select Output 7

Table 3-1 Pin Definitions and Functions (PG-LQFP-144-17 package) (cont'd)

Pin	Symbol	Ctrl.	Type	Function
77	P1.11	I/O0	A1+/ PU	Port 1 General Purpose I/O Line 11
	IN27	I		GPTA0 Input 27
	IN51	I		GPTA0 Input 51
	SCLK1B	I		SSC1 Clock Input B
	CCU61	I		CCPOS0C
	GPT120	I		T2INB
	GPT121	I		T2INA
	OUT27	O1		GPTA0 Output 27
	OUT51	O2		GPTA0 Output 51
	SCLK1B	O3		SSC1 Clock Output B
93	P1.15	I/O0	A2/ PU	Port 1 General Purpose I/O Line 15
	BRKIN	I		Break Input
	Reserved	O1		-
	Reserved	O2		-
	Reserved	O3		-
	BRKOUT	O		Break Output (controlled by OCDS module)
Port 2				
61	P2.0	I/O0	A2/ PU	Port 2 General Purpose I/O Line 0
	IN32	I		GPTA0 Input 32
	CCU60	I		CC62INB
	CCU61	I		CC62INA
	OUT32	O1		GPTA0 Output 32
	TCLK0	O2		MLI0 Transmitter Clock Output 0
	CCU61	O3		CC62

تهیه و توزیع قطعات الکترونیک

Table 3-1 Pin Definitions and Functions (PG-LQFP-144-17 package) (cont'd)

Pin	Symbol	Ctrl.	Type	Function
62	P2.1	I/O0	A2/ PU	Port 2 General Purpose I/O Line 1
	IN33	I		GPTA0 Input 33
	TREADY0A	I		MLI0 Transmitter Ready Input A
	CCU61	I		CCPOS0A
	CCU60	I		T12HRB
	GPT120	I		T2INA
	GPT121	I		T2INB
	OUT33	O1		GPTA0 Output 33
	SLSO03	O2		SSC0 Slave Select Output Line 3
	SLSO13	O3		SSC1 Slave Select Output Line 3
63	P2.2	I/O0	A2/ PU	Port 2 General Purpose I/O Line 2
	IN34	I		GPTA0 Input 34
	CCU60	I		CC61INB
	CCU61	I		CC61INA
	OUT34	O1		GPTA0 Output 34
	TVALID0A	O2		MLI0 Transmitter Valid Output
	CCU61	O3		CC61
64	P2.3	I/O0	A2/ PU	Port 2 General Purpose I/O Line 3
	IN35	I		GPTA0 Input 35
	CCU60	I		T12HRC
	CCU60	I		T13HRC
	CCU61	I		CCPOS2A
	GPT120	I		T4EUDA
	GPT121	I		T4EADB
	OUT35	O1		GPTA0 Output 35
	TDATA0	O2		MLI0 Transmitter Data Output
	Reserved	O3		-

Table 3-1 Pin Definitions and Functions (PG-LQFP-144-17 package) (cont'd)

Pin	Symbol	Ctrl.	Type	Function
65	P2.4	I/O0	A2/ PU	Port 2 General Purpose I/O Line 4
	IN36	I		GPTA0 Input 36
	RCLK0A	I		MLI Receiver Clock Input A
	OUT36	O1		GPTA0 Output 36
	CCU61	O2		COUT63
	Reserved	O3		-
66	P2.5	I/O0	A2/ PU	Port 2 General Purpose I/O Line 5
	IN37	I		GPTA0 Input 37
	CCU60	I		CC60INB
	CCU61	I		CC60INA
	OUT37	O1		GPTA0 Output 37
	RREADY0A	O2		MLI0 Receiver Ready Output A
	CCU61	O3		CC60
67	P2.6	I/O0	A2/ PU	Port 2 General Purpose I/O Line 6
	IN38	I		GPTA0 Input 38
	RVALID0A	I		MLI Receiver Valid Input A
	Reserved	I		-
	OUT38	O1		GPTA0 Output 38
	CCU61	O2		COUT62
	Reserved	O3		-
68	P2.7	I/O0	A2/ PU	Port 2 General Purpose I/O Line 7
	RDATA0A	I		MLI Receiver Data Input A
	IN39	I		GPTA0 Input 39
	OUT39	O1		GPTA0 Output 39
	CCU61	O2		COUT60
	Reserved	O3		-
132	P2.8	I/O0	A2/ PU	Port 2 General Purpose I/O Line 8
	SLSO04	O1		SSC0 Slave Select Output 4
	SLSO14	O2		SSC1 Slave Select Output 4
	EN00	O3		MSC0 Enable Output 0

Table 3-1 Pin Definitions and Functions (PG-LQFP-144-17 package) (cont'd)

Pin	Symbol	Ctrl.	Type	Function
128	P2.9	I/O0	A2/ PU	Port 2 General Purpose I/O Line 9
	SLSO05	O1		SSC0 Slave Select Output 5
	SLSO15	O2		SSC1 Slave Select Output 5
	EN01	O3		MSC0 Enable Output 1
129	P2.10	I/O0	A1+/ PU	Port 2 General Purpose I/O Line 10
	MRST1A	I		SSC1 Master Receive Input A
	MRST1A	O1		SSC1 Slave Transmit Output
	Reserved	O2		-
	Reserved	O3		-
130	P2.11	I/O0	A1+/ PU	Port 2 General Purpose I/O Line 11
	SCLK1A	I		SSC1 Clock Input A
	SCLK1A	O1		SSC1 Clock Output A
	Reserved	O2		-
	FCLP0B	O3		MSC0 Clock Output Positive B
131	P2.12	I/O0	A1+/ PU	Port 2 General Purpose I/O Line 12
	MTSR1A	I		SSC1 Slave Receive Input A
	MTSR1A	O1		SSC1 Master Transmit Output A
	Reserved	O2		-
	SOP0B	O3		MSC0 Serial Data Output Positive B
133	P2.13	I/O0	A1+/ PU	Port 2 General Purpose I/O Line 13
	SLSI11	I		SSC1 Slave Select Input 1
	SDI0	I		MSC0 Serial Data Input 0
	CCU60	I		CTRAPA
	CCU61	I		T12HRE
	Reserved	O1		-
	SLSO16	O2		SSC1 Slave Select Output 6
	GPT120	O3		T6OUT

Port 3

Table 3-1 Pin Definitions and Functions (PG-LQFP-144-17 package) (cont'd)

Pin	Symbol	Ctrl.	Type	Function
112	P3.0	I/O0	A1+/ PU	Port 3 General Purpose I/O Line 0
	RXD0A	I		ASC0 Receiver Input A (Async. & Sync. Mode)
	REQ6	I		External Request Input 6
	RXD0A	O1		ASC0 Output (Sync. Mode)
	Reserved	O2		-
	OUT84	O3		GPTA0 Output 84
111	P3.1	I/O0	A1+/ PU	Port 3 General Purpose I/O Line 1
	TXD0	O1		ASC0 Output
	Reserved	O2		-
	OUT85	O3		GPTA0 Output 85
105	P3.2	I/O0	A1+/ PU	Port 3 General Purpose I/O Line 2
	SCLK0	I		SSC0 Clock Input (Slave Mode)
	SCLK0	O1		SSC0 Clock Output (Master Mode)
	Reserved	O2		-
	OUT86	O3		GPTA0 Output 86
106	P3.3	I/O0	A1+/ PU	Port 3 General Purpose I/O Line 3
	MRST0	I		SSC0 Master Receive Input (Master Mode)
	MRST0	O1		SSC0 Slave Transmit Output (Slave Mode)
	Reserved	O2		-
	OUT87	O3		GPTA0 Output 87
108	P3.4	I/O0	A2/ PU	Port 3 General Purpose I/O Line 4
	MTRS0	I		SSC0 Slave Receive Input (Slave Mode)
	MTRS0	O1		SSC0 Master Transmit Output (Master Mode)
	Reserved	O2		-
	OUT88	O3		GPTA0 Output 88
102	P3.5	I/O0	A1+/ PU	Port 3 General Purpose I/O Line 5
	SLSO00	O1		SSC0 Slave Select Output 0
	SLSO10	O2		SSC1 Slave Select Output 0
	SLSOAND00	O3		SSC0 AND SSC1 Slave Select Output 0

Table 3-1 Pin Definitions and Functions (PG-LQFP-144-17 package) (cont'd)

Pin	Symbol	Ctrl.	Type	Function
103	P3.6	I/O0	A1/ PU	Port 3 General Purpose I/O Line 6
	SLSO01	O1		SSC0 Slave Select Output 1
	SLSO11	O2		SSC1 Slave Select Output 1
	SLSOANDO1	O3		SSC0 AND SSC1 Slave Select Output 1
107	P3.7	I/O0	A2/ PU	Port 3 General Purpose I/O Line 7
	SLSI0	I		SSC0 Slave Select Input 1
	SLSO02	O1		SSC0 Slave Select Output 2
	SLSO12	O2		SSC1 Slave Select Output 2
	OUT89	O3		GPTA0 Output 89
104	P3.8	I/O0	A2/ PU	Port 3 General Purpose I/O Line 8
	REQ14	I		External Request Input 14
	SLSO06	O1		SSC0 Slave Select Output 6
	TXD1	O2		ASC1 Transmit Output
	OUT90	O3		GPTA0 Output 90
114	P3.9	I/O0	A1/ PU	Port 3 General Purpose I/O Line 9
	RXD1A	I		ASC1 Receiver Input A
	RXD1A	O1		ASC1 Receiver Output A (Synchronous Mode)
	Reserved	O2		-
	OUT91	O3		GPTA0 Output 91
113	P3.10	I/O0	A1/ PU	Port 3 General Purpose I/O Line 10
	REQ0	I		External Request Input 0
	Reserved	O1		-
	Reserved	O2		-
	OUT92	O3		GPTA0 Output 92
120	P3.11	I/O0	A1/ PU	Port 3 General Purpose I/O Line 11
	REQ1	I		External Request Input 1
	Reserved	O1		-
	Reserved	O2		-
	OUT93	O3		GPTA0 Output 93

Table 3-1 Pin Definitions and Functions (PG-LQFP-144-17 package) (cont'd)

Pin	Symbol	Ctrl.	Type	Function
119	P3.12	I/O0	A1/ PU	Port 3 General Purpose I/O Line 12
	RXDCAN0	I		CAN Node 0 Receiver Input
	RXD0B	I		ASC0 Receiver Input B
	RXD0B	O1		ASC0 Receiver Output B (Synchronous Mode)
	Reserved	O2		-
	OUT94	O3		GPTA0 Output 94
118	P3.13	I/O0	A2/ PU	Port 3 General Purpose I/O Line 13
	TXDCAN0	O1		CAN Node 0 Transmitter Output
	TXD0	O2		ASC0 Transmit Output
	OUT95	O3		GPTA0 Output 95
110	P3.14	I/O0	A1/ PU	Port 3 General Purpose I/O Line 14
	RXDCAN1	I		CAN Node 1 Receiver Input
	RXD1B	I		ASC1 Receiver Input B
	SDI2	I		MSC0 Serial Data Input 2
	RXD1B	O1		ASC1 Receiver Output B (Synchronous Mode)
	Reserved	O2		-
OUT96	O3	GPTA0 Output 96		
109	P3.15	I/O0	A2/ PU	Port 3 General Purpose I/O Line 15
	TXDCAN1	O1		CAN Node 1 Transmitter Output
	TXD1	O2		ASC1 Transmit Output
	OUT97	O3		GPTA0 Output 97

Port 4

تهیه و توزیع قطعات الکترونیک

Table 3-1 Pin Definitions and Functions (PG-LQFP-144-17 package) (cont'd)

Pin	Symbol	Ctrl.	Type	Function
72	P4.2	I/O0	A2/ PU	Port 4 General Purpose I/O Line 2
	IN30	I		GPTA0 Input 30
	IN54	I		GPTA0 Input 54
	CCU60	I		T13HRB
	CCU61	I		CCPOS1A
	GPT120	I		T2EUDA
	GPT121	I		T2EUDB
	OUT30	O1		GPTA0 Output 30
	OUT54	O2		GPTA0 Output 54
	EXTCLK1	O3		External Clock 1 Output
73	P4.3	I/O0	A2/ PU	Port 4 General Purpose I/O Line 3
	IN31	I		GPTA0 Input 31
	IN55	I		GPTA0 Input 55
	CCU60	I		T12HRE
	CCU61	I		CTRAPA
	OUT31	O1		GPTA0 Output 31
	OUT55	O2		GPTA0 Output 55
	EXTCLK0	O3		External Clock 0 Output
	Port 5			
1	P5.0	I/O0	A1+/ PU	Port 5 General Purpose I/O Line 0
	REQ7	I		External Request Input 7
	IN40	I		GPTA0 Input 40
	CCU60	I		CC62INA
	CCU61	I		CC62INB
	GPT120	I		CAPINB
	GPT121	I		CAPINA
	OUT40	O1		GPTA0 Output 40
	CCU60	O2		CC62
	SLSO20	O3		SSC2 Slave Select Output 0

Table 3-1 Pin Definitions and Functions (PG-LQFP-144-17 package) (cont'd)

Pin	Symbol	Ctrl.	Type	Function
2	P5.1	I/O0	A1+/ PU	Port 5 General Purpose I/O Line 1
	IN41	I		GPTA0 Input 41
	OUT41	O1		GPTA0 Output 41
	Reserved	O2		-
	SLSO21	O3		SSC2 Slave Select Output 1
3	P5.2	I/O0	A1+/ PU	Port 5 General Purpose I/O Line 2
	IN42	I		GPTA0 Input 42
	OUT42	O1		GPTA0 Output 42
	CCU60	O2		COUT62
	SLSO22	O3		SSC2 Slave Select Output 2
4	P5.3	I/O0	A1+/ PU	Port 5 General Purpose I/O Line 3
	IN43	I		GPTA0 Input 43
	OUT43	O1		GPTA0 Output 43
	Reserved	O2		-
	SLSO23	O3		SSC2 Slave Select Output 3
7	P5.4	I/O0	A1+/ PU	Port 5 General Purpose I/O Line 4
	IN44	I		GPTA0 Input 44
	SLSI2A	I		SSC2 Slave Select Input A
	OUT44	O1		GPTA0 Output 44
	Reserved	O2		-
	SLSO24	O3		SSC2 Slave Select Output 4
8	P5.5	I/O0	A1+/ PU	Port 5 General Purpose I/O Line 5
	IN45	I		GPTA0 Input 45
	MRST2A	I		SSC2 Master Receive Input A (Master Mode)
	OUT45	O1		GPTA0 Output 45
	Reserved	O2		-
	MRST2	O3		SSC2 Slave Transmit Output (Slave Mode)

Pinning

Table 3-1 Pin Definitions and Functions (PG-LQFP-144-17 package) (cont'd)

Pin	Symbol	Ctrl.	Type	Function
9	P5.6	I/O0	A1+/ PU	Port 5 General Purpose I/O Line 6
	IN46	I		GPTA0 Input 46
	MTSR2A	I		SSC2 Slave Receive Input (Slave Mode)
	OUT46	O1		GPTA0 Output 46
	Reserved	O2		-
	MTSR2	O3		SSC2 Master Transmit Output (Master Mode)
10	P5.7	I/O0	A1+/ PU	Port 5 General Purpose I/O Line 7
	IN47	I		GPTA0 Input 47
	SCLK2A	I		SSC2 Clock Input A (Slave Mode)
	OUT47	O1		GPTA0 Output 47
	Reserved	O2		-
	SCLK2	O3		SSC2 Clock Output (Master Mode)
15	P5.8	I/O0	A2/ PU	Port 5 General Purpose I/O Line 8
	CCU60	I		CC61INA
	CCU61	I		CC61INB
	OUT6	O1		GPTA0 Output 6
	TXDA1	O2		E-Ray Channel A transmit Data Output ¹⁾
	CCU60	O3		CC61
16	P5.9	I/O0	A2/ PU	Port 5 General Purpose I/O Line 9
	RXDCAN0	I		CAN Node 0 Receiver Input
	OUT7	O1		GPTA0 Output 7
	TXDB1	O2		E-Ray Channel B transmit Data Output ¹⁾
	Reserved	O3		-
17	P5.10	I/O0	A2/ PU	Port 5 General Purpose I/O Line 10
	OUT8	O1		GPTA0 Output 8
	TXENA	O2		E-Ray Channel A transmit Data Output enable ¹⁾
	CCU60	O3		COUT61

Table 3-1 Pin Definitions and Functions (PG-LQFP-144-17 package) (cont'd)

Pin	Symbol	Ctrl.	Type	Function
18	P5.11	I/O0	A2/ PU	Port 5 General Purpose I/O Line 11
	OUT9	O1		GPTA0 Output 9
	TXENB	O2		E-Ray Channel B transmit Data Output enable ¹⁾
	CCU60	O3		COU63
19	P5.12	I/O0	A1+/ PU	Port 5 General Purpose I/O Line 12
	CCU60	I		CCPOS0A
	CCU61	I		T12HRB
	GPT120	I		T3INA
	GPT121	I		T3INB
	OUT19	O1		GPTA0 Output 19
	SLSO07	O2		SSC0 Slave Select Output 7
	AD1EMUX0	O3		ADC1 External Multiplexer Control Output 0
20	P5.13	I/O0	A1+/ PU	Port 5 General Purpose I/O Line 13
	CCU60	I		CCPOS1A
	CCU61	I		T13HRB
	GPT120	I		T3EUDA
	GPT121	I		T3EADB
	OUT20	O1		GPTA0 Output 20
	Reserved	O2		-
	AD1EMUX1	O3		ADC1 External Multiplexer Control Output 1
21	P5.14	I/O0	A1+/ PU	Port 5 General Purpose I/O Line 14
	RXDA1	I		E-Ray Channel A Receive Data Input 1 ¹⁾
	CCU60	I		CCPOS2A
	CCU61	I		T12HRC
	CCU61	I		T13HRC
	GPT120	I		T4INA
	GPT121	I		T4INB
	OUT36	O1		GPTA0 Output 36
	Reserved	O2		-
	AD1EMUX2	O3		ADC1 External Multiplexer Control Output 2

Table 3-1 Pin Definitions and Functions (PG-LQFP-144-17 package) (cont'd)

Pin	Symbol	Ctrl.	Type	Function
11	P5.15	I/O0	A1+/PU	Port 5 General Purpose I/O Line 15
	RXDB1	I		E-Ray Channel B Receive Data Input 1¹⁾
	OUT37	O1		GPTA0 Output 37
	Reserved	O2		-
	TXDCAN0	O3		CAN Node 0 Transmitter Output
Port 8				
117	P8.0	I/O0	A2/PU	Port 8 General Purpose I/O Line 0
	SCLK3	I		SSC3 Clock Input (Slave Mode)
	CCU60	I		CCPOS0C
	GPT120	I		T3INB
	GPT121	I		T3INA
	Reserved	O1		-
	OUT48	O2		GPTA0 Output 48
	SCLK3	O3		SSC3 Clock Output (Master Mode)
116	P8.1	I/O0	A2/PU	Port 8 General Purpose I/O Line 1
	MRST3	I		SSC3 Master Receive Input (Master Mode)
	CCU60	I		CCPOS1C
	GPT120	I		T3EUDB
	GPT121	I		T3EUDA
	Reserved	O1		-
	OUT49	O2		GPTA0 Output 49
	MRST3	O3		SSC3 Slave Transmit Output (Slave Mode)
115	P8.2	I/O0	A2/PU	Port 8 General Purpose I/O Line 2
	MTRS3	I		SSC3 Slave Receive Input (Slave Mode)
	CCU60	I		CCPOS2C
	GPT120	I		T4INB
	GPT121	I		T4INA
	Reserved	O1		-
	OUT50	O2		GPTA0 Output 50
	MTRS3	O3		SSC3 Master Transmit Output (Master Mode)

Table 3-1 Pin Definitions and Functions (PG-LQFP-144-17 package) (cont'd)

Pin	Symbol	Ctrl.	Type	Function
100	P8.3	I/O0	A2/ PU	Port 8 General Purpose I/O Line 3
	SLSI3	I		SSC3 Slave Select Input B
	CCU60	I		CC61INC
	CCU61	O1		CC61
	OUT51	O2		GPTA0 Output 51
	SLSO30	O3		SSC3 Slave Select Output 0
99	P8.4	I/O0	A2/ PU	Port 8 General Purpose I/O Line 4
	OUT99	O1		GPTA0 Output 99
	CCU61	O2		COUT62
	SLSO31	O3		SSC3 Slave Select Output 1
69	P8.5	I/O0	A2/ PU	Port 8 General Purpose I/O Line 5
	CCU60	I		CC60INC
	OUT100	O1		GPTA0 Output 100
	CCU61	O2		CC60
	SLSO32	O3		SSC3 Slave Select Output 2
70	P8.6	I/O0	A2/ PU	Port 8 General Purpose I/O Line 6
	OUT101	O1		GPTA0 Output 101
	Reserved	O2		-
	CCU61	O3		COUT61
71	P8.7	I/O0	A2/ PU	Port 8 General Purpose I/O Line 7
	CCU60	I		CC62INC
	OUT102	O1		GPTA0 Output 102
	Reserved	O2		-
	CCU61	O3		CC62
101	P8.13	I/O0	A2/ PU	Port 8 General Purpose I/O Line 13
	OUT4	O1		GPTA0 Output 4
	Reserved	O2		-
	CCU61	O3		COUT60

Port 9

Pinning

Table 3-1 Pin Definitions and Functions (PG-LQFP-144-17 package) (cont'd)

Pin	Symbol	Ctrl.	Type	Function
5	P9.0	I/O0	A1/ PU	Port 9 General Purpose I/O Line 0
	RXDCAN2	I		CAN Node 2 Receiver Input
	Reserved	O1		-
	OUT80	O2		GPTA0 Output 80
	Reserved	O3		-
6	P9.1	I/O0	A2/ PU	Port 9 General Purpose I/O Line 1
	TXDCAN2	O1		CAN Node 2 Transmitter Output
	OUT81	O2		GPTA0 Output 81
	Reserved	O3		-
140	P9.2	I/O0	A1/ PU	Port 9 General Purpose I/O Line 2
	Reserved	O1		-
	OUT82	O2		GPTA0 Output 82
	CCU60	O3		COUT63
139	P9.3	I/O0	A1/ PU	Port 9 General Purpose I/O Line 3
	Reserved	O1		-
	OUT83	O2		GPTA0 Output 83
	CCU60	O3		COUT62
138	P9.4	I/O0	A1/ PU	Port 9 General Purpose I/O Line 4
	CCU61	I		CC62INC
	Reserved	O1		-
	OUT84	O2		GPTA0 Output 84
	CCU60	O3		CC62
87	P9.5	I/O0	A2/ PU	Port 9 General Purpose I/O Line 5
	TDI	I		JTAG Serial Data Input
	BRKIN	I		OCDS Break Input
	Reserved	O1		-
	Reserved	O2		-
	Reserved	O3		-
	BRKOUT	O		OCDS Break Output (controlled by OCDS module)

Table 3-1 Pin Definitions and Functions (PG-LQFP-144-17 package) (cont'd)

Pin	Symbol	Ctrl.	Type	Function
89	P9.6	I/O0	A2/ PU	Port 9 General Purpose I/O Line 6
	TDO	I		JTAG Serial Data Output
	BRKIN	I		OCDS Break Input
	Reserved	O1		-
	Reserved	O2		-
	Reserved	O3		-
	BRKOUT	O		OCDS Break Output (controlled by OCDS module)
	TDO	O		JTAG Serial Data Output (controlled by OCDS module)
13	P9.7	I/O0	A1/ PU	Port 9 General Purpose I/O Line 7
	CCU61	I		CC60INC
	Reserved	O1		-
	OUT87	O2		GPTA0 Output 87
	CCU60	O3		CC60
14	P9.8	I/O0	A1/ PU	Port 9 General Purpose I/O Line 7
	Reserved	O1		-
	OUT88	O2		GPTA0 Output 88
	CCU60	O3		COUT60

Port 11

38	P11.0	I	D / S	Port 11 General Purpose I/O Line 0²⁾
	Dig0	I		Digital Input 0
	AN16	I		Analog Input : ADC1.CH0³⁾
37	P11.3	I	D / S	Port 11 General Purpose I/O Line 3²⁾
	Dig3	I		Digital Input 3
	AN19	I		Analog Input : ADC1.CH3³⁾
36	P11.7	I	D / S	Port 11 General Purpose I/O Line 7²⁾
	Dig7	I		Digital Input 7
	AN23	I		Analog Input : ADC1.CH7³⁾

Table 3-1 Pin Definitions and Functions (PG-LQFP-144-17 package) (cont'd)

Pin	Symbol	Ctrl.	Type	Function
35	P11.9	I	D / S	Port 11 General Purpose I/O Line 9 ²⁾
	Dig9	I		Digital Input 9
	AN25	I		Analog Input : ADC1.CH9 ³⁾
Port 12				
29	P12.0	I	D / S	Port 12 General Purpose I/O Line 0 ²⁾
	Dig16	I		Digital Input 16
	AN36	I		Analog Input : ADC1.CH20 ³⁾
28	P12.1	I	D / S	Port 12 General Purpose I/O Line 1 ²⁾
	Dig17	I		Digital Input 17
	AN37	I		Analog Input : ADC1.CH21 ³⁾
27	P12.2	I	D / S	Port 12 General Purpose I/O Line 2 ²⁾
	Dig18	I		Digital Input 18
	AN38	I		Analog Input : ADC1.CH22 ³⁾
26	P12.3	I	D / S	Port 12 General Purpose I/O Line 3 ²⁾
	Dig19	I		Digital Input 19
	AN39	I		Analog Input : ADC1.CH23 ³⁾
Analog Input Port				
57	AN0	I	D	Analog Input 0: ADC0.CH0 ³⁾
56	AN1	I	D	Analog Input 1: ADC0.CH1 ³⁾
55	AN2	I	D	Analog Input 2: ADC0.CH2 ³⁾
54	AN3	I	D	Analog Input 3: ADC0.CH3 ³⁾
53	AN4	I	D	Analog Input 4: ADC0.CH4 ³⁾
52	AN5	I	D	Analog Input 5: ADC0.CH5 ³⁾
51	AN6	I	D	Analog Input 6: ADC0.CH6 ³⁾
34	AN7	I	D	Analog Input 7: ADC0.CH7 ³⁾
50	AN8	I	D	Analog Input 8: ADC0.CH8 ³⁾
49	AN9	I	D	Analog Input 9: ADC0.CH9 ³⁾
48	AN10	I	D	Analog Input 10: ADC0.CH10 ³⁾
47	AN11	I	D	Analog Input 11: ADC0.CH11 ³⁾
46	AN12	I	D	Analog Input 12: ADC0.CH12 ³⁾

Table 3-1 Pin Definitions and Functions (PG-LQFP-144-17 package) (cont'd)

Pin	Symbol	Ctrl.	Type	Function
45	AN13	I	D	Analog Input 13: ADC0.CH13 ³⁾
40	AN14	I	D	Analog Input 14: ADC0.CH14 ³⁾
39	AN15	I	D	Analog Input 15: ADC0.CH15 ³⁾
38	AN16	I	D / S	Analog Input 16: ADC1.CH0, Dig0 ³⁾
37	AN19	I	D / S	Analog Input 19: ADC1.CH3, Dig3 ³⁾
36	AN23	I	D / S	Analog Input 23: ADC1.CH7, Dig7 ³⁾
35	AN25	I	D / S	Analog Input 25: ADC1.CH9, Dig9 ³⁾
33	AN32	I	D	Analog Input 32: FADC_FADIN0P ⁴⁾
32	AN33	I	D	Analog Input 33: FADC_FADIN0N ⁴⁾
31	AN34	I	D	Analog Input 34: FADC_FADIN1P ⁴⁾
30	AN35	I	D	Analog Input 35: FADC_FADIN1N ⁴⁾
29	AN36	I	D / S	Analog Input 36: ADC1.CH20, Dig16 ³⁾
28	AN37	I	D / S	Analog Input 37: ADC1.CH21, Dig17 ³⁾
27	AN38	I	D / S	Analog Input 37: ADC1.CH22, Dig18 ³⁾
26	AN39	I	D / S	Analog Input 37: ADC1.CH23, Dig19 ³⁾
44	V_{DDM}	-	-	ADC Analog Part Power Supply (3.3V - 5V)
43	V_{SSM}	-	-	ADC Analog Part Ground
42	V_{AREF0}	-	-	ADC0 and ADC1 Reference Voltage
41	V_{AGND0}	-	-	ADC Reference Ground
12, 23 ⁵⁾ , 58, 84, 125	V_{DD}	-	-	Digital Core Power Supply (1.3V)
22, 59, 85, 126	V_{DDP}	-	-	Port Power Supply (3.3V)

Table 3-1 Pin Definitions and Functions (PG-LQFP-144-17 package) (cont'd)

Pin	Symbol	Ctrl.	Type	Function
24, 60, 86 127	V_5	-	-	EVR Power Supply (5V)
25	V_{PDG}	-	-	EVR Pass Device Gate If this pin is connected to ground, the internal pass devices are used and the external pass device bypassed.
80, 83	V_{SS}	-	-	Digital Ground
81	XTAL1	I		Main Oscillator Input
82	XTAL2	O		Main Oscillator Output
88	TMS	I	A2/ PD	JTAG State Machine Control Input
	DAP1	I/O		Device Access Port Line 1
90	TRST	I	A1/ PD	JTAG Reset Input
91	TCK	I	A1/ PD	JTAG Clock Input
	DAP0	I		Device Access Port Line 0
94	TESTMODE	I	I/PU	Test Mode Select Input
96	ESR1	I/O	A2/ PD	External System Request Reset Input 1
97	PORST	I	I/PU	Power On Reset
98	ESR0	I/O	A2	External System Request Reset Input 0 Default configuration during and after reset is open-drain driver. The driver drives low during power-on reset.

- 1) Only applicable for SAK-TC1724F-192F133HL, SAK-TC1724F-192F133HR.
- 2) Analog input overlaid with digital input functionality. The related port logic is used to configure the input as either analog input (default after reset) or digital input. The related port logic supports only the port input features as the connected pads are input only pads.
- 3) IOZ1 valid for this pin is the parameter with overlaid = No in the ADC parameter table.
- 4) IOZ1 valid for this pin is the parameter with overlaid = Yes in the ADC parameter table.
- 5) For the emulation device (ED), this pin is bonded to VDD_{SB} (ED Stand By RAM supply). In the production devide device, this pin is bonded to a VDD pad.

Legend for Table 3-1Column “**Ctrl.**”:I = Input (for GPIO port lines with IOCR bit field selection $PCx = 0XXX_B$)

O = Output

O0 = Output with IOCR bit field selection $PCx = 1X00_B$ O1 = Output with IOCR bit field selection $PCx = 1X01_B$ (ALT1)O2 = Output with IOCR bit field selection $PCx = 1X10_B$ (ALT2)O3 = Output with IOCR bit field selection $PCx = 1X11_B$ (ALT3)Column “**Type**”:

A1 = Pad class A1 (LVTTTL)

A1+ = Pad class A1+ (LVTTTL)

A2 = Pad class A2 (LVTTTL)

D = Pad class D (ADC)

I = Pad class I (LVTTTL)

S = Pad class D (ADC) / Pad class S (Digital)

PU = with pull-up device connected during reset ($\overline{PORST} = 0$)PD = with pull-down device connected during reset ($\overline{PORST} = 0$)TR = tri-state during reset ($\overline{PORST} = 0$)

تهیه و توزیع قطعات الکترونیک

4 Identification Registers

The Identification Registers uniquely identify the device.

Table 2 SAK-TC1724F-192F133HL Identification Registers

Short Name	Value	Address	Stepping
CBS_JDPID	0000 6350 _H	F000 0408 _H	AB
CBS_JTAGID	101D 0083 _H	F000 0464 _H	AB
SCU_MANID	0000 1820 _H	F000 0644 _H	AB
SCU_CHIPID	0300 A601 _H	F000 0640 _H	AB
SCU_RTID	0000 0001 _H	F000 0648 _H	AB

Table 3 SAK-TC1724F-192F133HR Identification Registers

Short Name	Value	Address	Stepping
CBS_JDPID	0000 6350 _H	F000 0408 _H	AB
CBS_JTAGID	101D 0083 _H	F000 0464 _H	AB
SCU_MANID	0000 1820 _H	F000 0644 _H	AB
SCU_CHIPID	8300 A601 _H	F000 0640 _H	AB
SCU_RTID	0000 0001 _H	F000 0648 _H	AB

Table 4 SAK-TC1724F-192F133HR Identification Registers

Short Name	Value	Address	Stepping
CBS_JDPID	0000 6350 _H	F000 0408 _H	AC
CBS_JTAGID	101D 0083 _H	F000 0464 _H	AC
SCU_MANID	0000 1820 _H	F000 0644 _H	AC
SCU_CHIPID	8300 A601 _H	F000 0640 _H	AC
SCU_RTID	0000 0002 _H	F000 0648 _H	AC

Table 5 SAK-TC1724N-192F133HR Identification Registers

Short Name	Value	Address	Stepping
CBS_JDPID	0000 6350 _H	F000 0408 _H	AC
CBS_JTAGID	101D 0083 _H	F000 0464 _H	AC
SCU_MANID	0000 1820 _H	F000 0644 _H	AC

Identification Registers

Table 5 SAK-TC1724N-192F133HR Identification Registers (cont'd)

Short Name	Value	Address	Stepping
SCU_CHIPID	8300 9B01 _H	F000 0640 _H	AC
SCU_RTID	0000 0002 _H	F000 0648 _H	AC

Table 6 SAK-TC1724N-192F80HL Identification Registers

Short Name	Value	Address	Stepping
CBS_JDPID	0000 6350 _H	F000 0408 _H	AB
CBS_JTAGID	101D 0083 _H	F000 0464 _H	AB
SCU_MANID	0000 1820 _H	F000 0644 _H	AB
SCU_CHIPID	1300 9B01 _H	F000 0640 _H	AB
SCU_RTID	0000 0001 _H	F000 0648 _H	AB

Table 7 SAK-TC1724N-192F80HR Identification Registers

Short Name	Value	Address	Stepping
CBS_JDPID	0000 6350 _H	F000 0408 _H	AB
CBS_JTAGID	101D 0083 _H	F000 0464 _H	AB
SCU_MANID	0000 1820 _H	F000 0644 _H	AB
SCU_CHIPID	9300 9B01 _H	F000 0640 _H	AB
SCU_RTID	0000 0001 _H	F000 0648 _H	AB

Table 8 SAK-TC1724N-192F80HR Identification Registers

Short Name	Value	Address	Stepping
CBS_JDPID	0000 6350 _H	F000 0408 _H	AC
CBS_JTAGID	101D 0083 _H	F000 0464 _H	AC
SCU_MANID	0000 1820 _H	F000 0644 _H	AC
SCU_CHIPID	9300 9B01 _H	F000 0640 _H	AC
SCU_RTID	0000 0002 _H	F000 0648 _H	AC

5 Electrical Parameters

This specification provides all electrical parameters of the TC1724.

5.1 General Parameters

5.1.1 Parameter Interpretation

The parameters listed in this section partly represent the characteristics of the TC1724 and partly its requirements on the system. To aid interpreting the parameters easily when evaluating them for a design, they are marked with an two-letter abbreviation in column "Symbol":

- **CC**
Such parameters indicate **C**ontroller **C**haracteristics which are a distinctive feature of the TC1724 and must be regarded for a system design.
- **SR**
Such parameters indicate **S**ystem **R**equirements which must provided by the microcontroller system in which the TC1724 designed in.

The SKYTECH logo features the word "SKYTECH" in a large, bold, grey, sans-serif font. The letter 'S' is stylized with a white diagonal line. The letter 'T' has a white arrow pointing upwards from its base.

تهیه و توزیع قطعات الکترونیک

5.1.2 Pad Driver and Pad Classes Summary

This section gives an overview on the different pad driver classes and its basic characteristics. More details (mainly DC parameters) are defined in the [Section 5.2.1](#).

Table 9 Pad Driver and Pad Classes Overview

Class	Power Supply	Type	Sub Class	Speed Grade	Load	Leakage ¹⁾ 150°C	Termination
A	3.3 V	LVTTTL I/O, LVTTTL outputs	A1 (e.g. GPIO)	6 MHz	100 pF	500 nA	No
			A1+ (e.g. serial I/Os)	25 MHz	50 pF	1 μA	Series termination recommended
			A2 (e.g. serial I/Os)	40 MHz	50 pF	3 μA	Series termination recommended
DE	5 V	ADC	–	–	–	–	
I	3.3 V	LVTTTL (input only)	–	–	–	–	

1) Two values are given: for $T_j = 150\text{ °C}$ and a 50% higher value for $T_j = 160\text{ °C}$.

5.1.3 Absolute Maximum Ratings

Stresses above the values listed under “Absolute Maximum Ratings” may cause permanent damage to the device. This is a stress rating only and functional operation of the device at these or any other conditions above those indicated in the operational sections of this specification is not implied. Exposure to absolute maximum rating conditions may affect device reliability.

Table 10 Absolute Maximum Rating Parameters

Parameter	Symbol		Values			Unit	Note / Test Condition
			Min.	Typ.	Max.		
Storage temperature	T_{ST}	SR	-65	–	160	°C	–
Voltage at 1.3 V power supply pins with respect to V_{SS}	V_{DD}	SR	–	–	2.0	V	–
Voltage at 3.3 V power supply pins with respect to V_{SS}	V_{DDP} SR		–	–	4.33	V	–
Voltage at 5 V power supply pins with respect to V_{SS}	V_{DDM}	SR	–	–	7.0	V	–
Voltage on any Class A input pin and dedicated input pins with respect to V_{SS}	V_{IN}	SR	-0.6	–	$V_{DDP} + 0.5$ or max. 4.33	V	Whatever is lower
Voltage on any Class D analog input pin with respect to V_{AGND}	V_{AIN} V_{AREF_x}	SR	-0.6	–	7.0	V	–
Voltage on any shared Class D analog input pin with respect to V_{SSAF} , if the FADC is switched through to the pin.	V_{AINF}	SR	-0.6	–	7.0	V	–
Input current on any pin during overload condition	I_{IN}		-10	–	+10	mA	
Absolute maximum sum of all input circuit currents for one port group during overload condition ¹⁾	I_{IN}		-75	–	+75	mA	
Absolute maximum sum of all input circuit currents during overload condition	ΣI_{IN}		–	–	[200]	mA	

- 1) The port groups are defined in [Table 15](#).



5.1.4 Pin Reliability in Overload

When receiving signals from higher voltage devices, low-voltage devices experience overload currents and voltages that go beyond their own IO power supplies specification.

Table 11 defines overload conditions that will not cause any negative reliability impact if all the following conditions are met:

- full operation life-time (24000 h) is not exceeded
- **Operating Conditions** are met for
 - pad supply levels (V_{DDP} or V_{DDM})
 - temperature

If a pin current is out of the **Operating Conditions** but within the overload parameters, then the parameters functionality of this pin as stated in the Operating Conditions can no longer be guaranteed. Operation is still possible in most cases but with relaxed parameters.

Note: An overload condition on one or more pins does not require a reset.

Table 11 Overload Parameters

Parameter	Symbol	Values			Unit	Note / Test Condition
		Min.	Typ.	Max.		
Input current on any digital pin during overload condition	I_{IN}	-5	–	+5	mA	
Absolute sum of all input circuit currents for one port group during overload condition ¹⁾	I_{ING}	-70	–	+70	mA	
Input current on analog pins	I_{INANA}	-3	–	+3	mA	
Absolute sum of all analog input currents for analog inputs of a single ADC during overload condition	I_{INSAS}	-15	–	+15	mA	
Absolute sum of all input circuit currents during overload condition	ΣI_{INS}	-100	–	100	mA	

1) The port groups are defined in **Table 15**.

Note: FADC input pins count as analog pin as they are overlaid with an ADC pins.

Table 12 PN-Junction Characteristics for positive Overload

Pad Type	$I_{IN} = 3 \text{ mA}$	$I_{IN} = 5 \text{ mA}$
A1 / A1+	$U_{IN} = V_{DDP} + 0.6 \text{ V}$	$U_{IN} = V_{DDP} + 0.7 \text{ V}$
A2	$U_{IN} = V_{DDP} + 0.5 \text{ V}$	$U_{IN} = V_{DDP} + 0.6 \text{ V}$
D / S	$U_{IN} = V_{DDM} + 0.6 \text{ V}$	-

Table 13 PN-Junction Characteristics for negative Overload

Pad Type	$I_{IN} = -3 \text{ mA}$	$I_{IN} = -5 \text{ mA}$
A1 / A1+	$U_{IN} = V_{SS} - 0.6 \text{ V}$	$U_{IN} = V_{SS} - 0.7 \text{ V}$
A2	$U_{IN} = V_{SS} - 0.5 \text{ V}$	$U_{IN} = V_{SS} - 0.6 \text{ V}$
D / S	$U_{IN} = V_{SSM} - 0.6 \text{ V}$	-

Note: A series resistor at the pin to limit the current to the maximum permitted overload current is sufficient to handle failure situations like short to battery without having any negative reliability impact on the operational life-time.



 تهیه و توزیع قطعات الکترونیک

Electrical Parameters
5.1.5 Operating Conditions

The following operating conditions must not be exceeded in order to ensure correct operation and reliability of the TC1724. All parameters specified in the following tables refer to these operating conditions, unless otherwise noticed.

Digital supply voltages applied to the TC1724 from external must be static regulated voltages which allow a typical voltage swing of $\pm 5\%$.

All parameters specified in the following tables refer to these operating conditions (**Table 14**), unless otherwise noticed in the Note / Test Condition column.

Table 14 Operating Conditions Parameters

Parameter	Symbol		Values			Unit	Note / Test Condition
			Min.	Typ	Max.		
Overload coupling factor for analog inputs, negative	K_{OVAN}	CC	–	–	0.0001		$I_{OV} \geq -2$ mA; $I_{OV} \leq 0$ mA; analog pad= 5.0 V
Overload coupling factor for analog inputs, positive	K_{OVAP}	CC	–	–	0.00001		$I_{OV} \geq 0$ mA; $I_{OV} \leq 3$ mA; analog pad= 5.0 V
CPU Frequency	f_{CPU}	SR	–	–	133	MHz	SAK-TC1724F-192F133HL; SAK-TC1724F-192F133HR; SAK-TC1724N-192F133HR
			–	–	80	MHz	SAK-TC1724N-192F80HL; SAK-TC1724N-192F80HR

تهیه و توزیع قطعات الکترونیک

Electrical Parameters

Table 14 Operating Conditions Parameters (cont'd)

Parameter	Symbol	SR	Values			Unit	Note / Test Condition
			Min.	Typ	Max.		
FPI Frequency	f_{FPI}	SR	-	-	110	MHz	SAK-TC1724F-192F133HL; SAK-TC1724F-192F133HR; SAK-TC1724N-192F133HR
			-	-	80	MHz	SAK-TC1724N-192F80HL; SAK-TC1724N-192F80HR
LMB Frequency	f_{LMB}	SR	-	-	133	MHz	SAK-TC1724F-192F133HL; SAK-TC1724F-192F133HR; SAK-TC1724N-192F133HR
			-	-	80	MHz	SAK-TC1724N-192F80HL; SAK-TC1724N-192F80HR
PCP Frequency	f_{PCP}	SR	-	-	133	MHz	SAK-TC1724F-192F133HL; SAK-TC1724F-192F133HR; SAK-TC1724N-192F133HR
			-	-	80	MHz	SAK-TC1724N-192F80HL; SAK-TC1724N-192F80HR
Inactive device pin current	I_{ID}	SR	-1	-	1	mA	All power supply voltages $V_{DDx} = 0$
Short circuit current of digital outputs ¹⁾	I_{SC}	SR	-5	-	5	mA	

Electrical Parameters

Table 14 Operating Conditions Parameters (cont'd)

Parameter	Symbol		Values			Unit	Note / Test Condition
			Min.	Typ	Max.		
Absolute sum of short circuit currents of the device	ΣI_{SC_D}	CC	–	–	100	mA	
Absolute sum of short circuit currents per pin group	ΣI_{SC_PG}	CC	–	–	70	mA	
Ambient Temperature	T_A	SR	-40	–	125	°C	
Junction temperature	T_J	SR	-40	–	160	°C	
Core Supply Voltage	V_{DD}	SR	1.17	1.3	1.43 ²⁾	V	Only required if externally supplied ⁵⁾
ADC analog supply voltage	V_{DDM}	SR	2.97	5.0	5.5 ³⁾	V	
EVR supply voltage	V_5	SR	4.00	5.0	5.5	V	5.0V single supply
			2.97	3.3	3.63	V	3.3V single supply
Digital supply voltage for IO pads	V_{DDP}	SR	2.97	3.3	3.63 ⁴⁾	V	Only required if externally supplied ⁵⁾
VDDP voltage to ensure defined pad states ⁶⁾	V_{DDPPA}	CC	0.65	–	–	V	
Digital ground voltage	V_{SS}	SR	0	–	–	V	
Analog ground voltage for V_{DDM}	V_{SSM}	SR	-0.1	0	0.1	V	

1) Applicable for digital outputs.

 2) Voltage overshoot to 1.7V is permissible at Power-Up and \overline{PORST} low, provided the pulse duration is less than 100 μ s and the cumulated sum of the pulses does not exceed 1 h.

 3) Voltage overshoot to 6.5V is permissible at Power-Up and \overline{PORST} low, provided the pulse duration is less than 100 μ s and the cumulated sum of the pulses does not exceed 1 h.

 4) Voltage overshoot to 4.0V is permissible at Power-Up and \overline{PORST} low, provided the pulse duration is less than 100 μ s and the cumulated sum of the pulses does not exceed 1 h.

5) No external inductive load permissible if EVR is used.

 6) This parameter is valid under the assumption the \overline{PORST} signal is constantly at low level during the power-up/power-down of V_{DDP} .

Table 15 Pin Groups for Overload / Short-Circuit Current Sum Parameter

Group	Pins
1	P5.[15:2], P9.[1:0], P9.[8:7]
2	P0.[7:0], P0.[15:12], P2.[13:8], P3.[1:0], P3.[4:3], P3.7, P3.[15:9], P5.[1:0], P8.[2:0], P9.[4:2]
3	P1.[1:0], P1.15, P3.2, P3.[6:5], P3.8, P8.[4:3], P8.13, P9.[6:5]
4	P1.[4:3], P1.[11:8], P2.[7:0], P4.[3:2], P8.[7:5]



تهیه و توزیع قطعات الکترونیک

5.2 DC Parameters

5.2.1 Input/Output Pins

Table 16 Standard_Pads Parameters

Parameter	Symbol	Values			Unit	Note / Test Condition
		Min.	Typ.	Max.		
Pin capacitance (digital inputs/outputs)	C_{IO} CC	–	–	10	pF	$T_A = 25\text{ °C}$; $f = 1\text{ MHz}$
Pull-down current	$ I_{PDL} $ CC	–	–	150	μA	$V_i \geq 0.6 \times V_{DDP}$ V
		10	–	–	μA	$V_i \geq 0.36 \times V_{DDP}$ V
Pull-Up current	$ I_{PUH} $ CC	10	–	–	μA	$V_i \leq 0.6 \times V_{DDP}$ V
		–	–	100	μA	$V_i \leq 0.36 \times V_{DDP}$ V
Spike filter always blocked pulse duration	t_{SF1} CC	–	–	10	ns	only PORST pin
Spike filter pass-through pulse duration	t_{SF2} CC	120	–	–	ns	only PORST pin

Table 17 Standard_Pads Class_A1

Parameter	Symbol	Values			Unit	Note / Test Condition
		Min.	Typ.	Max.		
Input Hysteresis for pads of all A classes ¹⁾	$HYSA$ CC	$0.1 \times V_{DDP}$	–	–	V	
Input Leakage Current Class A1	I_{OZA1} CC	-500	–	500	nA	$V_i \leq V_{DDP}$ V; $V_i \geq 0$ V; $-40\text{ °C} \leq T_j \leq 150\text{ °C}$
		-750	–	750	nA	$V_i \leq V_{DDP}$ V; $V_i \geq 0$ V; $150\text{ °C} < T_j \leq 160\text{ °C}$
Ratio V_{iL}/V_{iH} , A1 pads	V_{ILA1} / V_{IHA1} CC	0.6	–	–		

Electrical Parameters

Table 17 Standard_Pads Class_A1 (cont'd)

Parameter	Symbol	Values			Unit	Note / Test Condition
		Min.	Typ.	Max.		
On-Resistance of the class A1 pad, weak driver	R_{DSONW} CC	-	450	600	Ohm	$I_{OH} > -0.5$ mA; P_MOS
		-	210	340	Ohm	$I_{OL} < 0.5$ mA; N_MOS
On-Resistance of the class A1 pad, medium driver	R_{DSONM} CC	-	-	155	Ohm	$I_{OH} > -2$ mA; P_MOS
		-	-	110	Ohm	$I_{OL} < 2$ mA; N_MOS
Fall time, pad type A1	t_{FA1} CC	-	-	150	ns	$C_L = 20$ pF; pin out driver= weak
		-	-	50	ns	$C_L = 50$ pF; pin out driver= medium
		-	-	140	ns	$C_L = 150$ pF; pin out driver= medium
		-	-	550	ns	$C_L = 150$ pF; pin out driver= weak
		-	-	18000	ns	$C_L = 20000$ pF; pin out driver= medium
		-	-	65000	ns	$C_L = 20000$ pF; pin out driver= weak
Rise time, pad type A1	t_{RA1} CC	-	-	150	ns	$C_L = 20$ pF; pin out driver= weak
		-	-	50	ns	$C_L = 50$ pF; pin out driver= medium
		-	-	140	ns	$C_L = 150$ pF; pin out driver= medium
		-	-	550	ns	$C_L = 150$ pF; pin out driver= weak
		-	-	18000	ns	$C_L = 20000$ pF; pin out driver= medium
		-	-	65000	ns	$C_L = 20000$ pF; pin out driver= weak

Electrical Parameters

Table 17 Standard_Pads Class_A1 (cont'd)

Parameter	Symbol	Values			Unit	Note / Test Condition
		Min.	Typ.	Max.		
Input high voltage, class A1 pads	V_{IHA1} SR	$0.6 \times V_{DDP}$	–	$\min(V_D, V_{DP} + 0.3, 3.6)$	V	
Input low voltage, class A1 pads	V_{ILA1} SR	-0.3	–	$0.36 \times V_{DDP}$	V	
Output voltage high, class A1 pads	V_{OHA1} CC	$V_{DDP} - 0.4$	–	–	V	$I_{OH} \geq -1.4$ mA; pin out driver= medium
		2.4	–	–	V	$I_{OH} \geq -2$ mA; pin out driver= medium
		$V_{DDP} - 0.4$	–	–	V	$I_{OH} \geq -400$ μ A; pin out driver= weak
		2.4	–	–	V	$I_{OH} \geq -500$ μ A; pin out driver= weak
Output voltage low, class A1 pads	V_{OLA1} CC	–	–	0.4	V	$I_{OL} \leq 2$ mA; pin out driver= medium
		–	–	0.4	V	$I_{OL} \leq 500$ μ A; pin out driver= weak

1) Hysteresis is implemented to avoid metastable states and switching due to internal ground bounce. It can't be guaranteed that it suppresses switching due to external system noise.

Table 18 Standard_Pads Class_A1+

Parameter	Symbol	Values			Unit	Note / Test Condition
		Min.	Typ.	Max.		
Input Hysteresis for A1+ pads ¹⁾	HYS_{A1+} CC	$0.1 \times V_{DDP}$	–	–	V	
Input Leakage Current Class A1+	I_{OZA1+} CC	-1000	–	1000	nA	

Electrical Parameters

Table 18 Standard_Pads Class_A1+ (cont'd)

Parameter	Symbol	Values			Unit	Note / Test Condition
		Min.	Typ	Max.		
On-Resistance of the class A1+ pad, weak driver	R_{DSONW} CC	–	450	600	Ohm	$I_{OH} > -0.5$ mA; P_MOS
		–	210	340	Ohm	$I_{OL} < 0.5$ mA; N_MOS
On-Resistance of the class A1+ pad, medium driver	R_{DSONM} CC	–	–	155	Ohm	$I_{OH} > -2$ mA; P_MOS
		–	–	110	Ohm	$I_{OL} < 2$ mA; N_MOS
On-Resistance of the class A1+ pad, strong driver	R_{DSON1+} CC	–	–	110	Ohm	$I_{OH} > -2$ mA; P_MOS
		–	–	80	Ohm	$I_{OL} < 2$ mA; N_MOS
Fall time, pad type A1+	t_{FA1+} C	–	–	150	ns	$C_L = 20$ pF; pin out driver= weak
		–	–	28	ns	$C_L = 50$ pF; edge= slow; pin out driver= strong
		–	–	16	ns	$C_L = 50$ pF; edge= soft ; pin out driver= strong
		–	–	50	ns	$C_L = 50$ pF; pin out driver= medium
		–	–	140	ns	$C_L = 150$ pF; pin out driver= medium
		–	–	550	ns	$C_L = 150$ pF; pin out driver= weak
		–	–	18000	ns	$C_L = 20000$ pF; pin out driver= medium
		–	–	65000	ns	$C_L = 20000$ pF; pin out driver= weak

Electrical Parameters

Table 18 Standard_Pads Class_A1+ (cont'd)

Parameter	Symbol	Values			Unit	Note / Test Condition
		Min.	Typ	Max.		
Rise time, pad type A1+	t_{RA1+} C	–	–	150	ns	$C_L = 20$ pF; pin out driver= weak
	C	–	–	28	ns	$C_L = 50$ pF; edge= slow ; pin out driver= strong
		–	–	16	ns	$C_L = 50$ pF; edge= soft ; pin out driver= strong
		–	–	50	ns	$C_L = 50$ pF; pin out driver= medium
		–	–	140	ns	$C_L = 150$ pF; pin out driver= medium
		–	–	550	ns	$C_L = 150$ pF; pin out driver= weak
		–	–	18000	ns	$C_L = 20000$ pF; pin out driver= medium
		–	–	65000	ns	$C_L = 20000$ pF; pin out driver= weak
Input high voltage, Class A1+ pads	V_{IHA1+} SR	$0.6 \times V_{DDP}$	–	$\min(V_{D_{DP} + 0.3, 3.6})$	V	
Input low voltage, Class A1+ pads	V_{ILA1+} SR	-0.3	–	$0.36 \times V_{DDP}$	V	
Ratio V_{il}/V_{ih} , A1+ pads	V_{ILA1+} / V_{IHA1+} CC	0.6	–	–		

Electrical Parameters

Table 18 Standard_Pads Class_A1+ (cont'd)

Parameter	Symbol	Values			Unit	Note / Test Condition
		Min.	Typ.	Max.		
Output voltage high, class A1+ pads	$V_{OHA1+CC}$	$V_{DDP} - 0.4$	–	–	V	$I_{OH} \geq -1.4$ mA; pin out driver= medium
		$V_{DDP} - 0.4$	–	–	V	$I_{OH} \geq -1.4$ mA; pin out driver= strong
		2.4	–	–	V	$I_{OH} \geq -2$ mA; pin out driver= medium
		2.4	–	–	V	$I_{OH} \geq -2$ mA; pin out driver= strong
		$V_{DDP} - 0.4$	–	–	V	$I_{OH} \geq -400$ μ A; pin out driver= weak
		2.4	–	–	V	$I_{OH} \geq -500$ μ A; pin out driver= weak
Output voltage low, class A1+ pads	$V_{OLA1+CC}$	–	–	0.4	V	$I_{OL} \leq 2$ mA; pin out driver= medium
		–	–	0.4	V	$I_{OL} \leq 2$ mA; pin out driver= strong
		–	–	0.4	V	$I_{OL} \leq 500$ μ A; pin out driver= weak

1) Hysteresis is implemented to avoid metastable states and switching due to internal ground bounce. It can't be guaranteed that it suppresses switching due to external system noise.

Table 19 Standard_Pads Class_A2

Parameter	Symbol	Values			Unit	Note / Test Condition
		Min.	Typ.	Max.		
Input Hysteresis for A2 pads ¹⁾	HYS_{A2CC}	$0.1 \times V_{DDP}$	–	–	V	

Electrical Parameters

Table 19 Standard_Pads Class_A2 (cont'd)

Parameter	Symbol	Values			Unit	Note / Test Condition
		Min.	Typ.	Max.		
Input Leakage current Class A2	I_{OZA2} CC	-6000	–	6000	nA	$V_i < V_{DDP} / 2 - 1 \text{ V};$ $V_i > V_{DDP} / 2 + 1 \text{ V};$ $V_i \geq 0 \text{ V};$ $V_i \leq V_{DDP} \text{ V}$
		-3000	–	3000	nA	$V_i > V_{DDP} / 2 - 1 \text{ V};$ $V_i < V_{DDP} / 2 + 1 \text{ V}$
Ratio V_{iL}/V_{iH} , A2 pads	V_{ILA2} / V_{IHA2} CC	0.6	–	–		
On-Resistance of the class A2 pad, weak driver	R_{DSONW} CC	–	450	600	Ohm	$I_{OH} > -0.5 \text{ mA};$ P_MOS
		–	210	340	Ohm	$I_{OL} < 0.5 \text{ mA};$ N_MOS
On-Resistance of the class A2 pad, medium driver	R_{DSONM} CC	–	–	155	Ohm	$I_{OH} > -2 \text{ mA};$ P_MOS
		–	–	110	Ohm	$I_{OL} < 2 \text{ mA};$ N_MOS
On-Resistance of the class A2 pad, strong driver	R_{DSON2} CC	–	–	42	Ohm	$I_{OH} > -2 \text{ mA};$ P_MOS
		–	–	22	Ohm	$I_{OL} < 2 \text{ mA};$ N_MOS



تهیه و توزیع قطعات الکترونیک

Electrical Parameters

Table 19 Standard_Pads Class_A2 (cont'd)

Parameter	Symbol	Values			Unit	Note / Test Condition
		Min.	Typ.	Max.		
Fall time, pad type A2	t_{FA2} CC	–	–	150	ns	$C_L = 20$ pF; pin out driver= weak
		–	–	7	ns	$C_L = 50$ pF; edge= medium ; pin out driver= strong
		–	–	10	ns	$C_L = 50$ pF; edge= medium-minus ; pin out driver= strong
		–	–	3.7	ns	$C_L = 50$ pF; edge= sharp ; pin out driver= strong
		–	–	5	ns	$C_L = 50$ pF; edge= sharp-minus ; pin out driver= strong
		–	–	16	ns	$C_L = 50$ pF; edge= soft ; pin out driver= strong
		–	–	50	ns	$C_L = 50$ pF; pin out driver= medium
		–	–	7.5	ns	$C_L = 100$ pF; edge= sharp ; pin out driver= strong
		–	–	140	ns	$C_L = 150$ pF; pin out driver= medium

Electrical Parameters

Table 19 Standard_Pads Class_A2 (cont'd)

Parameter	Symbol	Values			Unit	Note / Test Condition
		Min.	Typ.	Max.		
Rise time, pad type A2	$t_{RA2\ CC}$	–	–	550	ns	$C_L = 150\text{ pF}$; pin out driver= weak
		–	–	18000	ns	$C_L = 20000\text{ pF}$; pin out driver= medium
		–	–	65000	ns	$C_L = 20000\text{ pF}$; pin out driver= weak
		–	–	150	ns	$C_L = 20\text{ pF}$; pin out driver= weak
		–	–	7.0	ns	$C_L = 50\text{ pF}$; edge= medium ; pin out driver= strong
		–	–	10	ns	$C_L = 50\text{ pF}$; edge= medium-minus ; pin out driver= strong
		–	–	3.7	ns	$C_L = 50\text{ pF}$; edge= sharp ; pin out driver= strong
		–	–	5	ns	$C_L = 50\text{ pF}$; edge= sharp-minus ; pin out driver= strong
		–	–	16	ns	$C_L = 50\text{ pF}$; edge= soft ; pin out driver= strong
		–	–	50	ns	$C_L = 50\text{ pF}$; pin out driver= medium
		–	–	7.5	ns	$C_L = 100\text{ pF}$; edge= sharp ; pin out driver= strong
		–	–	140	ns	$C_L = 150\text{ pF}$; pin out driver= medium

Electrical Parameters

Table 19 Standard_Pads Class_A2 (cont'd)

Parameter	Symbol	Values			Unit	Note / Test Condition
		Min.	Typ.	Max.		
		–	–	550	ns	$C_L = 150$ pF; pin out driver= weak
		–	–	18000	ns	$C_L = 20000$ pF; pin out driver= medium
		–	–	65000	ns	$C_L = 20000$ pF; pin out driver= weak
Input high voltage, class A2 pads	V_{IHA2} SR	$0.6 \times V_{DDP}$	–	$\min(V_{DDP} + 0.3, 3.6)$	V	
Input low voltage, Class A2 pads	V_{ILA2} SR	-0.3	–	$0.36 \times V_{DDP}$	V	
Output voltage high, class A2 pads	V_{OHA2} CC	$V_{DDP} - 0.4$	–	–	V	$I_{OH} \geq -1.4$ mA; pin out driver= medium
		$V_{DDP} - 0.4$	–	–	V	$I_{OH} \geq -1.4$ mA; pin out driver= strong
		2.4	–	–	V	$I_{OH} \geq -2$ mA; pin out driver= medium
		2.4	–	–	V	$I_{OH} \geq -2$ mA; pin out driver= strong
		$V_{DDP} - 0.4$	–	–	V	$I_{OH} \geq -400$ μ A; pin out driver= weak
		2.4	–	–	V	$I_{OH} \geq -500$ μ A; pin out driver= weak
Output voltage low, class A2 pads	V_{OLA2} CC	–	–	0.4	V	$I_{OL} \leq 2$ mA; pin out driver= medium
		–	–	0.4	V	$I_{OL} \leq 2$ mA; pin out driver= strong
		–	–	0.4	V	$I_{OL} \leq 500$ μ A; pin out driver= weak

1) Hysteresis is implemented to avoid metastable states and switching due to internal ground bounce. It can't be guaranteed that it suppresses switching due to external system noise.

Table 20 Standard_Pads Class_I

Parameter	Symbol	Values			Unit	Note / Test Condition
		Min.	Typ.	Max.		
Input Hysteresis Class I ¹⁾	<i>HYSI</i> CC	0.1 x V_{DDP}	–	–	V	
Input Leakage Current	I_{OZI} CC	-1000	–	1000	nA	$-40^{\circ}\text{C} \leq T_J \leq 150^{\circ}\text{C}$
		-1500	–	1500	nA	$150^{\circ}\text{C} < T_J \leq 160^{\circ}\text{C}$
Ratio between low and high input threshold	V_{ILI} / V_{IHI} CC	0.6	–	–		
Input high voltage, class I pins	V_{IHI} SR	0.6 x V_{DDP}	–	min(V_D DP + 0.3, 3.6)	V	
Input low voltage, Class I pads	V_{ILI} SR	-0.3	–	0.36 x V_{DDP}	V	

1) Hysteresis is implemented to avoid metastable states and switching due to internal ground bounce. It can't be guaranteed that it suppresses switching due to external system noise.

Class S pad parameters are only valid for $V_{DDM} = 4.75\text{ V}$ to 5.25 V .

Table 21 Standard_Pads Class_S

Parameter	Symbol	Values			Unit	Note / Test Condition
		Min.	Typ.	Max.		
Input Hysteresis for class S pads ¹⁾	<i>HYSS</i> CC	0.3	–	–	V	
Input leakage current	I_{OZS} CC	-300	–	300	nA	
Input voltage high	V_{IHS} CC	–	–	3.6	V	

Electrical Parameters

Table 21 Standard_Pads Class_S (cont'd)

Parameter	Symbol	Values			Unit	Note / Test Condition
		Min.	Typ.	Max.		
Input voltage low	V_{ILS} CC	1.9	–	–	V	
V_{ILS} Delta ²⁾	V_{ILSD} CC	-50	–	50	mV	Maximum input low state threshold variation over 1ms (V_{DDP} = constant)

- 1) Hysteresis is implemented to avoid metastable states and switching due to internal ground bounce. It can't be guaranteed that it suppresses switching due to external system noise.
- 2) V_{ILSD} is implemented to ensure J2716 specification. It can't be guaranteed that it suppresses switching due to external noise.

5.2.2 Analog to Digital Converters (ADCx)

ADC parameter in **Table 22** are valid for $V_{DD} = 1.235 \text{ V}$ to 1.365 V ; $V_{DDM} = 4.75 \text{ V}$ to 5.25 V ; $T_J = 150^\circ\text{C}$.

Table 22 5V ADC Parameters

Parameter	Symbol	Values			Unit	Note / Test Condition
		Min.	Typ.	Max.		
Switched capacitance at the analog voltage inputs ¹⁾	C_{AINSW} CC	–	9	20	pF	
Total capacitance of an analog input	C_{AINTOT} CC	–	20	30	pF	
Switched capacitance at the positive reference voltage input ²⁾³⁾	C_{AREFSW} CC	–	15	30	pF	
Total capacitance of the voltage reference inputs ²⁾	$C_{AREFTOT}$ CC	–	20	40	pF	
Differential Non-Linearity Error ⁴⁾⁵⁾⁶⁾⁷⁾	EA_{DNL} CC	-3	–	3	LSB	ADC resolution= 12-bit ^{8) 9)}
Gain Error ⁴⁾⁵⁾⁶⁾⁷⁾	EA_{GAIN} CC	-3.5	–	3.5	LSB	ADC resolution= 12-bit ^{8) 9)}
Integral Non-Linearity ⁴⁾⁵⁾⁶⁾⁷⁾	EA_{INL} CC	-3	–	3	LSB	ADC resolution= 12-bit ^{8) 9)}
Offset Error ⁴⁾⁵⁾⁶⁾⁷⁾	EA_{OFF} CC	-4	–	4	LSB	ADC resolution= 12-bit ^{8) 9)}

Electrical Parameters

Table 22 5V ADC Parameters (cont'd)

Parameter	Symbol	Values			Unit	Note / Test Condition
		Min.	Typ.	Max.		
Converter clock	f_{ADC} SR	4	–	110	MHz	SAK-TC1724F-192F133HL; SAK-TC1724F-192F133HR; SAK-TC1724N-192F133HR
		4	–	80	MHz	SAK-TC1724N-192F80HL; SAK-TC1724N-192F80HR
Internal ADC clock	f_{ADCI} CC	1	–	20	MHz	¹⁰⁾
Charge consumption per conversion	Q_{CONV} CC	70	85 ¹¹⁾	100	pC	charge needs to be provided via V_{AREF0}



تهیه و توزیع قطعات الکترونیک

Electrical Parameters

Table 22 5V ADC Parameters (cont'd)

Parameter	Symbol	Values			Unit	Note / Test Condition
		Min.	Typ.	Max.		
Input leakage at analog inputs ¹²⁾	I_{OZ1} CC	-100	–	500	nA	$V_i \geq 0.97 \times V_{DDM} V$; $V_i \leq V_{DDM} V$; overlaid= No
		-100	–	600	nA	$V_i \geq 0.97 \times V_{DDM} V$; $V_i \leq V_{DDM} V$; overlaid= Yes
		-500	–	100	nA	$V_i \geq 0 V$; $V_i \leq 0.03 \times V_{DDM} V$; overlaid= No
		-600	–	100	nA	$V_i \leq 0.03 \times V_{DDM} V$; $V_i \geq 0 V$; overlaid= Yes
		-100	–	200	nA	$V_i > 0.03 \times V_{DDM} V$; $V_i < 0.97 \times V_{DDM} V$; overlaid= No
		-100	–	300	nA	$V_i > 0.03 \times V_{DDM} V$; $V_i < 0.97 \times V_{DDM} V$; overlaid= Yes
Input leakage current at VAREF0	I_{OZ2} CC	-2	–	2	μA	$V_{AREF0} \geq 0V$; $V_{AREF0} \leq V_{DDM} V$
Input leakage current at VAGND0	I_{OZ3} CC	-2	–	2	μA	$V_{AGND0} \geq 0V$; $V_{AGND0} \leq V_{DDM} V$
ON resistance of the transmission gates in the analog voltage path	R_{AIN} CC	–	900	1500	Ohm	

Electrical Parameters

Table 22 5V ADC Parameters (cont'd)

Parameter	Symbol	Values			Unit	Note / Test Condition
		Min.	Typ.	Max.		
ON resistance for the ADC test (pull down for AIN7)	R_{AIN7T} CC	180	550	900	Ohm	Test feature available only for odd AINx pins
Resistance of the reference voltage input path	R_{AREF} CC	–	500	1000	Ohm	500 Ohm increased if AIN[1:0] used as reference input
Broken wire detection delay against VAGND	t_{BWG} CC	–	–	50	¹³⁾	
Broken wire detection delay against VAREF	t_{BWR} CC	–	–	50	¹⁴⁾	
Sample time	t_S CC	2	–	257	T_{ADCI}	
Calibration time after bit ADC_GLOBCFG.SUCAL is set	t_{CAL} CC	–	–	4352	cycles	
Total Unadjusted Error ⁵⁾⁶⁾¹⁵⁾	TUE CC	-4	–	4 ¹⁶⁾	LSB	ADC resolution= 12-bit
Wakeup time from analog powerdown, fast mode	t_{AWAF} CC	–	–	5	μs	
Wakeup time from analog powerdown, slow mode	t_{AWAS} CC	–	–	10	μs	
Analog reference ground ²⁾	V_{AGND0} SR	$V_{SSM} - 0.05$	–	$V_{AREF0} - V_{DDM}/2$	V	
Analog input voltage	V_{AIN} SR	V_{AGND0}	–	V_{AREF0}	V	
Analog reference voltage ²⁾	V_{AREF0} SR	$V_{AGND0} + V_{DDM}/2$	–	$V_{DDM} + 0.05$ ¹⁷⁾ ¹⁸⁾	V	
Analog reference voltage range ⁵⁾⁶⁾²⁾	$V_{AREF0} - V_{AGND0}$ SR	$V_{DDM}/2$	–	$V_{DDM} + 0.05$	V	

Electrical Parameters

- 1) The sampling capacity of the conversion C-network is pre-charged to $V_{AREF}/2$ before the sampling moment. Because of the parasitic elements the voltage measured at AINx can deviate from $V_{AREF}/2$.
- 2) Applies to AINx, when used as auxiliary reference input.
- 3) This represents an equivalent switched capacitance. This capacitance is not switched to the reference voltage at once. Instead smaller capacitances are successively switched to the reference voltage.
- 4) The sum of DNL/INL/GAIN/OFF errors does not exceed the related TUE total unadjusted error.
- 5) If the analog reference voltage range is below V_{DDM} but still in the defined range of $V_{DDM}/2$ and V_{DDM} is used, then the ADC converter errors increase. If the reference voltage is reduced by the factor k ($k < 1$), TUE, DNL, INL, Gain, and Offset errors increase also by the factor $1/k$.
- 6) If a reduced analog reference voltage between 1V and $V_{DDM}/2$ is used, then there are additional decrease in the ADC speed and accuracy.
- 7) If the analog reference voltage is $> V_{DDM}$, then the ADC converter errors increase.
- 8) For 10-bit conversions the error value must be multiplied with a factor 0.25.
- 9) For 8-bit conversions the error value must be multiplied with a factor 0.0625.
- 10) If the alternate reference is used or f_{ADCI} is more than 16 MHz, the accuracy of the ADC may decrease.
- 11) For a conversion time of $1 \mu s$ a rms value of $85 \mu A$ result for I_{AREF0} .
- 12) The leakage current definition is a continuous function, as shown in figure ADCx Analogue Input Leakage. The numerical values defined determine the characteristic points of the given continuous linear approximation - they do not define step function.
- 13) The broken wire detection delay against V_{AGND} is measured in numbers of consecutive precharge cycles at a conversion rate of not more than $250 \mu s$. Results below 10% (199_H).
- 14) The broken wire detection delay against V_{AREF} is measured in numbers of consecutive precharge cycles at a conversion rate of not more than $10 \mu s$. This function is influenced by leakage current, in particular at high temperature. Results above 60% (999_H).
- 15) Measured without noise.
- 16) For 10-bit conversion the TUE is $\pm 2LSB$; for 8-bit conversion the TUE is $\pm 1LSB$
- 17) A running conversion may become inexact in case of violating the normal conditions (voltage overshoot).
- 18) If the reference voltage V_{AREF} increase or the V_{DDM} decrease, so that $V_{AREF} = (V_{DDM} + 0.05V \text{ to } V_{DDM} + 0.07V)$, then the accuracy of the ADC decrease by $4LSB_{12}$.



Electrical Parameters

ADC parameter in **Table 23** are valid for $V_{DD} = 1.235\text{ V to }1.365\text{ V}$; $V_{DDM} = 3.135\text{ V to }3.465\text{ V}$; $T_j = 150^\circ\text{C}$.

Table 23 3.3V ADC Parameters

Parameter	Symbol	Values			Unit	Note / Test Condition
		Min.	Typ.	Max.		
Switched capacitance at the analog voltage inputs ¹⁾	$C_{AINSW\ CC}$	–	9	20	pF	
Total capacitance of an analog input	$C_{AINTOT\ CC}$	–	20	30	pF	
Switched capacitance at the positive reference voltage input ²⁾³⁾	$C_{AREFS\ W\ CC}$	–	15	30	pF	
Total capacitance of the voltage reference inputs ²⁾	$C_{AREFTO\ T\ CC}$	–	20	40	pF	
Differential Non-Linearity Error ⁴⁾⁵⁾⁶⁾⁷⁾	$EA_{DNL\ CC}$	-4	–	4	LSB	ADC resolution= 12-bit ^{8) 9)}
Gain Error ⁴⁾⁵⁾⁶⁾⁷⁾	$EA_{GAIN\ CC}$	-3.5	–	3.5	LSB	ADC resolution= 12-bit ^{8) 9)}
Integral Non-Linearity ⁴⁾⁵⁾⁶⁾⁷⁾	$EA_{INL\ CC}$	-4	–	4	LSB	ADC resolution= 12-bit ^{8) 9)}
Offset Error ⁴⁾⁵⁾⁶⁾⁷⁾	$EA_{OFF\ CC}$	-4	–	4	LSB	ADC resolution= 12-bit ^{8) 9)}
Converter clock	$f_{ADC\ SR}$	4	–	110	MHz	SAK-TC1724F-192F133HL; SAK-TC1724F-192F133HR; SAK-TC1724N-192F133HR
		4	–	80	MHz	SAK-TC1724N-192F80HL; SAK-TC1724N-192F80HR

Electrical Parameters

Table 23 3.3V ADC Parameters (cont'd)

Parameter	Symbol	Values			Unit	Note / Test Condition
		Min.	Typ.	Max.		
Internal ADC clock	f_{ADCl} CC	1	–	20	MHz	¹⁰⁾
Charge consumption per conversion ¹¹⁾	Q_{CONV} CC	–	–	70	pC	charge needs to be provided via V_{AREF0}
Input leakage at analog inputs ¹²⁾	I_{OZ1} C	-100	–	500	nA	$V_{\text{I}} \geq 0.97 \times V_{\text{DDM}}$ V; $V_{\text{I}} \leq V_{\text{DDM}}$ V; overlaid= No
		-100	–	600	nA	$V_{\text{I}} \geq 0.97 \times V_{\text{DDM}}$ V; $V_{\text{I}} \leq V_{\text{DDM}}$ V; overlaid= Yes
		-500	–	100	nA	$V_{\text{I}} \geq 0$ V; $V_{\text{I}} \leq 0.03 \times V_{\text{DDM}}$ V; overlaid= No
		-600	–	100	nA	$V_{\text{I}} \leq 0.03 \times V_{\text{DDM}}$ V; $V_{\text{I}} \geq 0$ V; overlaid= Yes
		-100	–	200	nA	$V_{\text{I}} > 0.03 \times V_{\text{DDM}}$ V; $V_{\text{I}} < 0.97 \times V_{\text{DDM}}$ V; overlaid= No
		-100	–	300	nA	$V_{\text{I}} > 0.03 \times V_{\text{DDM}}$ V; $V_{\text{I}} < 0.97 \times V_{\text{DDM}}$ V; overlaid= Yes
		Input leakage current at Varef	I_{OZ2} CC	-2	–	2
Input leakage current at Vagnd	I_{OZ3} CC	-2	–	2	μA	$V_{\text{AGND0}} \leq V_{\text{DDM}}$ V

Electrical Parameters

Table 23 3.3V ADC Parameters (cont'd)

Parameter	Symbol	Values			Unit	Note / Test Condition
		Min.	Typ.	Max.		
ON resistance of the transmission gates in the analog voltage path	R_{AIN} C	–	3500	9000	Ohm	
ON resistance for the ADC test (pull down for AIN7)	R_{AIN7T} CC	180	800	1800	Ohm	Test feature available only for odd AINx pins
Resistance of the reference voltage input path	R_{AREF} CC	–	1700	3000	Ohm	500 Ohm increased if AIN[1:0] used as reference input
Broken wire detection delay against VAGND	t_{BWD} CC	–	–	50	¹³⁾	
Broken wire detection delay against VAREF	t_{BWR} CC	–	–	50	¹⁴⁾	
Sample time	t_S CC	2	–	257	T_{ADCI}	
Calibration time after bit ADC_GLOBCFG.SUCAL is set	t_{CAL} CC	–	–	4352	cycles	
Total Unadjusted Error ⁵⁾⁶⁾¹⁵⁾	TUE CC	-4.5	–	4.5 ¹⁶⁾	LSB	ADC resolution= 12-bit
Analog reference ground ²⁾	V_{AGND0} SR	$V_{SSM} - 0.05$	–	$V_{AREF0} - V_{DDM}/2$	V	
Analog input voltage	V_{AIN} SR	V_{AGND0}	–	V_{AREF0}	V	
Analog reference voltage ²⁾	V_{AREF0} SR	$V_{AGND0} + V_{DDM}/2$	–	$V_{DDM} + 0.05$ ¹⁷⁾¹⁸⁾	V	
Analog reference voltage range ⁵⁾⁶⁾²⁾	$V_{AREF0} - V_{AGND0}$ SR	$V_{DDM}/2$	–	$V_{DDM} + 0.05$	V	

1) The sampling capacity of the conversion C-network is pre-charged to $V_{AREF}/2$ before the sampling moment. Because of the parasitic elements the voltage measured at AINx can deviate from $V_{AREF}/2$.

Electrical Parameters

- 2) Applies to AINx, when used as auxiliary reference input.
- 3) This represents an equivalent switched capacitance. This capacitance is not switched to the reference voltage at once. Instead smaller capacitances are successively switched to the reference voltage.
- 4) The sum of DNL/INL/GAIN/OFF errors does not exceed the related TUE total unadjusted error.
- 5) If the analog reference voltage range is below V_{DDM} but still in the defined range of $V_{DDM} / 2$ and V_{DDM} is used, then the ADC converter errors increase. If the reference voltage is reduced by the factor k ($k < 1$), TUE, DNL, INL, Gain, and Offset errors increase also by the factor $1/k$.
- 6) If a reduced analog reference voltage between $1V$ and $V_{DDM} / 2$ is used, then there are additional decrease in the ADC speed and accuracy.
- 7) If the analog reference voltage is $> V_{DDM}$, then the ADC converter errors increase.
- 8) For 10-bit conversions the error value must be multiplied with a factor 0.25.
- 9) For 8-bit conversions the error value must be multiplied with a factor 0.0625.
- 10) If the alternate reference is used, or f_{ADCI} is more than 16 MHz, or STC is lower than 8, the accuracy of the ADC may decrease.
- 11) Q_{CONV} is calculated as $Q_{CONV} = C_{AREF} * V_{AREF}$. The Q_{CONV} can be calculated according to this formula.
- 12) The leakage current definition is a continuous function, as shown in figure ADCx Analogue Input Leakage. The numerical values defined determine the characteristic points of the given continuous linear approximation - they do not define step function.
- 13) The broken wire detection delay against V_{AGND} is measured in numbers of consecutive precharge cycles at a conversion rate of not more than $250\mu s$. Results below 10% (199_H).
- 14) The broken wire detection delay against V_{AREF} is measured in numbers of consecutive precharge cycles at a conversion rate of not more than $10\mu s$. This function is influenced by leakage current, in particular at high temperature. Results above 60% (999_H).
- 15) Measured without noise.
- 16) For 10-bit conversion the TUE is $\pm 2LSB$; for 8-bit conversion the TUE is $\pm 1LSB$
- 17) A running conversion may become inexact in case of violating the normal conditions (voltage overshoot).
- 18) If the reference voltage V_{AREF} increase or the V_{DDM} decrease, so that $V_{AREF} = (V_{DDM} + 0.05V$ to $V_{DDM} + 0.07V)$, then the accuracy of the ADC decrease by 4LSB12.

Table 24 Conversion Time (Operating Conditions apply)

Parameter	Symbol	Values	Unit	Note
Conversion time with post-calibration	t_C CC	$2 \times T_{ADC} + (4 + STC + n) \times T_{ADCI}$	μs	$n = 8, 10, 12$ for n -bit conversion $T_{ADC} = 1 / f_{FPI}$ $T_{ADCI} = 1 / f_{ADCI}$
Conversion time without post-calibration		$2 \times T_{ADC} + (2 + STC + n) \times T_{ADCI}$		

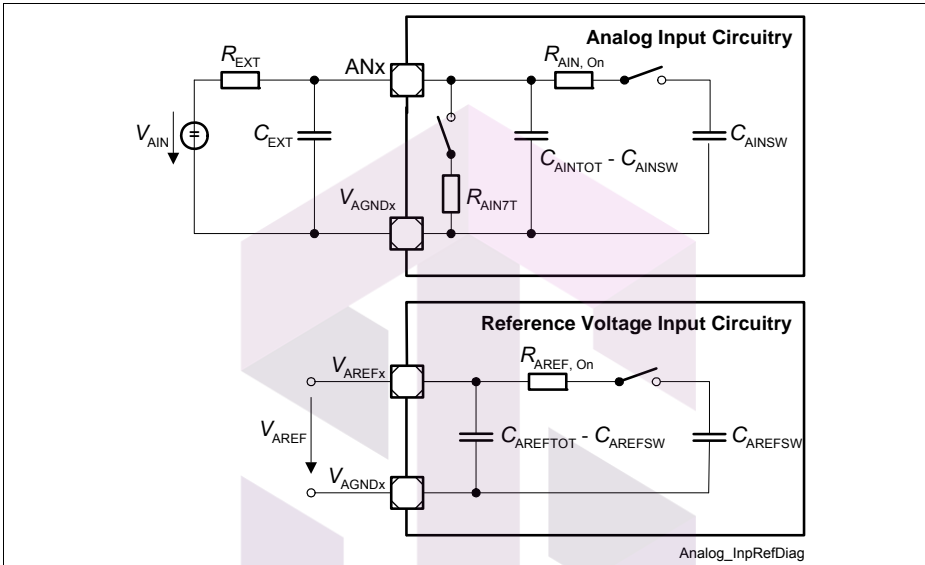

Figure 7 ADCx Input Circuits

SKYTECH

تهیه و توزیع قطعات الکترونیک

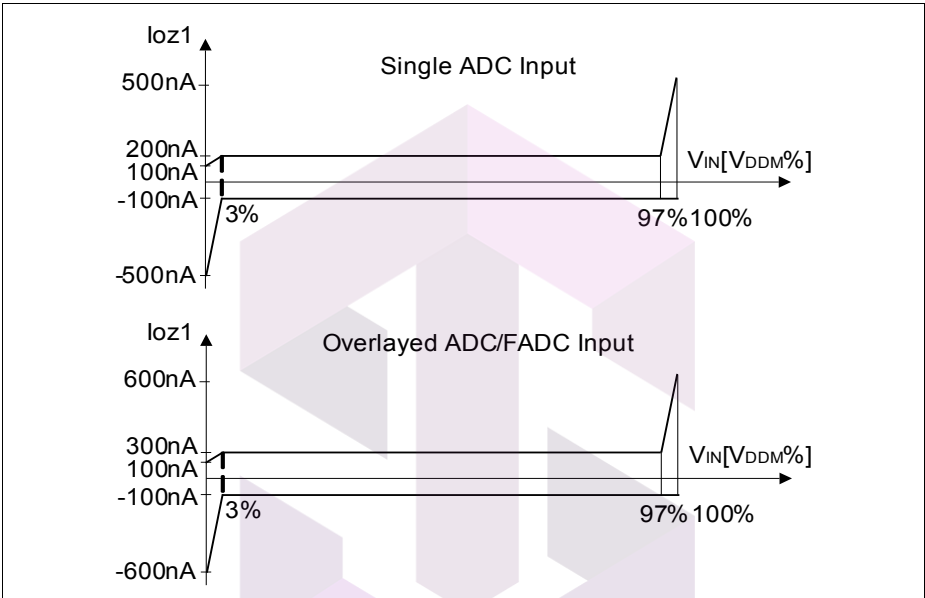

Figure 8 ADCx Analog Inputs Leakage

SKYTECH

تهیه و توزیع قطعات الکترونیک

Electrical Parameters

5.2.3 Fast Analog to Digital Converter (FADC)

FADC parameter are valid for $V_{DDM} = 4.75 \text{ V}$ to 5.25 V ; $T_J = 150^\circ\text{C}$.

 Table 25 FADC Parameters with $V_{DDM} = 5\text{V}$

Parameter	Symbol	Values			Unit	Note / Test Condition
		Min.	Typ.	Max.		
DNL error	$EF_{DNL\ CC}$	-1	-	1	LSB	V_{IN} mode= differential Gain = 1, 2
		-1	-	1	LSB	V_{IN} mode= single ended Gain = 1, 2
		-2	-	2	LSB	V_{IN} mode= differential Gain = 4, 8 $T_J = 150^\circ\text{C}$ ¹⁾
		-2.5	-	2.5	LSB	V_{IN} mode= differential Gain = 4, 8 $T_J = 160^\circ\text{C}$ ¹⁾
		-2	-	2	LSB	V_{IN} mode= single ended Gain = 4, 8 $T_J = 150^\circ\text{C}$ ¹⁾
		-2.5	-	2.5	LSB	V_{IN} mode= single ended Gain = 4, 8 $T_J = 160^\circ\text{C}$ ¹⁾

تهیه و توزیع قطعات الکترونیک

Electrical Parameters

 Table 25 FADC Parameters with $V_{DDM} = 5V$ (cont'd)

Parameter	Symbol	Values			Unit	Note / Test Condition
		Min.	Typ.	Max.		
GRADient error	EF_{GRAD} CC	-5	–	5	%	V_{IN} mode= differential ; Gain < 4
		-5	–	5	%	V_{IN} mode= single ended ; Gain < 4
		-5.5	–	5	%	V_{IN} mode= differential ; Gain = 4
		-5.5	–	5	%	V_{IN} mode= single ended ; Gain = 4
		-6	–	6	%	V_{IN} mode= differential ; Gain = 8
		-6	–	6	%	V_{IN} mode= single ended ; Gain = 8
INL error	EF_{INL} CC	-4	–	4	LSB	V_{IN} mode= differential
		-4	–	4	LSB	V_{IN} mode= single ended

 تهیه و توزیع قطعات الکترونیک

Electrical Parameters

 Table 25 FADC Parameters with $V_{DDM} = 5V$ (cont'd)

Parameter	Symbol	Values			Unit	Note / Test Condition
		Min.	Typ.	Max.		
Offset error	$EF_{OFF\ CC}$	-90	–	90	mV	V_{IN} mode= differential ; Calibration= No
		-90	–	90	mV	V_{IN} mode= single ended ; Calibration= No
		-20	–	20	mV	V_{IN} mode= differential ; Calibration= Yes ²⁾³⁾
		-20	–	20	mV	V_{IN} mode= single ended ; Calibration= Yes ²⁾³⁾
Error of common mode voltage $V_{FAREFI}/2$	$EF_{REFI\ CC}$	-80	–	80	mV	
Channel amplifier cutoff frequency	$f_{COFF\ CC}$	2	–	–	MHz	
Converter clock	$f_{FADC\ SR}$	4	–	110	MHz	SAK-TC1724F-192F133HL; SAK-TC1724F-192F133HR; SAK-TC1724N-192F133HR
		4	–	80	MHz	SAK-TC1724N-192F80HL; SAK-TC1724N-192F80HR
Conversion time	$t_c\ CC$	–	–	21	1 / f_{FADC}	For 10-bit conversion
Input resistance of the analog voltage path (R_n , R_p)	$R_{FAIN\ CC}$	100	–	200	kOhm	

Electrical Parameters

Table 25 FADC Parameters with $V_{DDM} = 5V$ (cont'd)

Parameter	Symbol	Values			Unit	Note / Test Condition
		Min.	Typ.	Max.		
Settling time of a channel amplifier after changing ENN or ENP	t_{SET} CC	–	–	5	μ S	
Analog input voltage range ⁴⁾	V_{AINF} SR	V_{SSM}	–	V_{DDP}	V	
Wakeup time from analog powerdown, fast mode	t_{FWAF} CC	–	–	5	μ S	
Wakeup time from analog powerdown, slow mode	t_{FWAS} CC	–	–	10	μ S	
Analog reference ground	V_{FAGNDI} CC	–	0	–	V	Internally generated
Analog reference voltage	V_{FAREFI} CC	–	3.3	– ⁵⁾⁶⁾	V	Internally generated

- 1) No missing codes.
- 2) Calibration should be performed at each power-up. In case of a continuous operation, it should be performed minimum once per week.
- 3) The offset error voltage drifts over the whole temperature range maximum $\pm 3LSB$.
- 4) The accuracy values is valid between 5% and 90% of V_{AINF}
- 5) Voltage overshoot to 4V is permissible, provided the pulse duration is less than 100 μ s and the cumulated sum of the pulses does not exceed 1 h.
- 6) A running conversion may become inexact in case of violating the normal operating conditions (voltage overshoots).

The calibration procedure should run after each power-up, when all power supply voltages and the reference voltage have stabilized.

SKYTECH
تهیه و توزیع قطعات الکترونیک

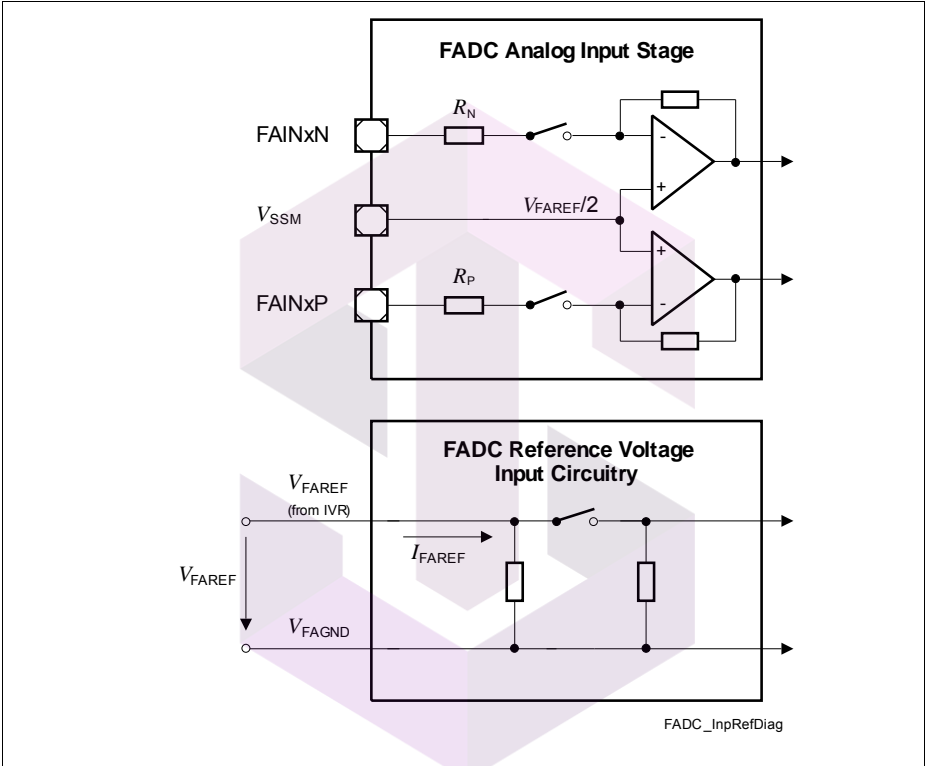

Figure 9 FADC Input Circuits

SKYTECH

تهیه و توزیع قطعات الکترونیک

5.2.4 Oscillator Pins

Table 26 OSC_XTAL Parameters

Parameter	Symbol	Values			Unit	Note / Test Condition
		Min.	Typ.	Max.		
Input current at XTAL1	I_{IX1} CC	-25	–	25	μA	$V_{IN} > 0 \text{ V};$ $V_{IN} < V_{DDP}$
Input frequency	f_{OSC} SR	4	–	40	MHz	Direct Input Mode selected
		8	–	25	MHz	External Crystal Mode selected
Oscillator start-up time ¹⁾	t_{OSCS} CC	–	–	10	ms	
Input high voltage at XTAL1 ²⁾	V_{IHx} SR	$0.7 \times V_{DDP}$	–	$V_{DDP} + 0.5$	V	
Input low voltage at XTAL1	V_{ILx} SR	-0.5	–	$0.3 \times V_{DDP}$	V	
Input hysteresis for XTAL1 pad ³⁾	HYSAX CC	–	–	200	mV	

1) t_{OSCS} is defined from the moment when $V_{DDP} = 3.13\text{V}$ until the oscillations reach an amplitude at XTAL1 of $0.3 * V_{DDP}$. The external oscillator circuitry must be optimized by the customer and checked for negative resistance as recommended and specified by crystal suppliers.

2) If the XTAL1 pin is driven by a crystal, reaching a minimum amplitude (peak-to-peak) of $0.3 * V_{DDP}$ is necessary.

3) Hysteresis is implemented to avoid metastable states and switching due to internal ground bounce. It can't be guaranteed that it suppresses switching due to external system noise.

Note: It is strongly recommended to measure the oscillation allowance (negative resistance) in the final target system (layout) to determine the optimal parameters for the oscillator operation. Please refer to the limits specified by the crystal or ceramic resonator supplier.

5.2.5 Power Supply Current

The total power supply current defined below consists of leakage and switching component.

Application relevant values are typically lower than those given in the following two tables and depend on the customer's system operating conditions (e.g. thermal connection or used application configurations).

The operating conditions for the parameters in the following table are:

$V_{DD}=1.365\text{ V}$, $V_{DDP}=3.47\text{ V}$, $V_{DDM}=5.1\text{ V}$, $f_{LMB}=133 / 80\text{ MHz}$, $T_J=160\text{ °C}$

The realistic power pattern defines the following conditions:

- $T_J=150\text{ °C}$
- $f_{LMB} = f_{PCP} = f_{CPU} = 133 / 80\text{ MHz}$
- $f_{FPI} = 66.5 / 80\text{ MHz}$
- $V_{DD} = 1.326\text{ V}$
- $V_{DDP} = 3.366\text{ V}$
- $V_{DDM} = 5.1\text{ V}$

The max power pattern defines the following conditions:

- $T_J=160\text{ °C}$
- $f_{LMB} = f_{PCP} = f_{CPU} = 133 / 80\text{ MHz}$
- $f_{FPI} = 66.5 / 80\text{ MHz}$
- $V_{DD} = 1.37\text{ V}$
- $V_{DDP} = 3.47\text{ V}$
- $V_{DDM} = 5.25\text{ V}$



 تهیه و توزیع قطعات الکترونیک

Electrical Parameters

Table 27 Power Supply Parameters

Parameter	Symbol	Values			Unit	Note / Test Condition
		Min	Typ.	Max.		
Core active mode supply current ¹⁾	I_{DD} CC	-	-	310	mA	power pattern= max ; SAK-TC1724F-192F133HL SAK-TC1724F-192F133HR SAK-TC1724N-192F133HR
		-	-	212	mA	power pattern= realistic ; SAK-TC1724F-192F133HL SAK-TC1724F-192F133HR SAK-TC1724N-192F133HR
		-	-	248	mA	power pattern= max ; SAK-TC1724N-192F80HL SAK-TC1724N-192F80HR
		-	-	160	mA	power pattern= realistic ; SAK-TC1724N-192F80HL SAK-TC1724N-192F80HR
I_{DD} current at PORST Low	I_{DD_PORST} CC	-	-	110	mA	
PORST pad output current	$I_{DDPORST}$ CC	13	-	-	mA	
Sum of all 1.3 V supply currents	I_{DDSUM} CC	-	-	212	mA	power pattern= realistic; SAK-TC1724F-192F133HL SAK-TC1724F-192F133HR SAK-TC1724N-192F133HR
		-	-	160	mA	power pattern= realistic ; SAK-TC1724N-192F80HL SAK-TC1724N-192F80HR SAK-TC1724F-192F80HR
I_{DDP} current at PORST Low	I_{DDP_PORS} T CC	-	-	6	mA	

Electrical Parameters

Table 27 Power Supply Parameters (cont'd)

Parameter	Symbol	Values			Unit	Note / Test Condition
		Min	Typ.	Max.		
I_{DDP} current no pad activity ²⁾	I_{DDP_CC}	–	–	$I_{DDP_PORST} + 83$	mA	including flash read current
		–	–	$I_{DDP_PORST} + 62$	mA	including flash programming current ³⁾
		–	–	$I_{DDP_PORST} + 91^{4)}$	mA	including flash erase verify current ³⁾
ADC 5V power supply current	I_{DDM_CC}	–	–	32	mA	
EVR Supply current	I_{V5_CC}	–	–	375	mA	power pattern= max; mode = 5V only with ext. pass device; SAK-TC1724F-192F133HL SAK-TC1724F-192F133HR
		–	–	370	mA	power pattern= max; mode = 5V only with ext. pass device SAK-TC1724N-192F133HR
		–	–	280	mA	power pattern= real; mode = 5V only with ext. pass device; SAK-TC1724F-192F133HL SAK-TC1724F-192F133HR
		–	–	275	mA	power pattern= real; mode = 5V only with ext. pass device; SAK-TC1724N-192F133HL SAK-TC1724N-192F133HR

Electrical Parameters

Table 27 Power Supply Parameters (cont'd)

Parameter	Symbol	Values			Unit	Note / Test Condition
		Min	Typ.	Max.		
EVR Supply current	I_{V5} CC	–	–	310	mA	power pattern= max; mode = 5V only without ext. pass device; SAK-TC1724N-192F80HL SAK-TC1724N-192F80HR
		–	–	235	mA	power pattern= real; mode = 5V only without ext. pass device; SAK-TC1724N-192F80HL SAK-TC1724N-192F80HR
Maximum power dissipation	PD CC	–	–	902	mW	power pattern= max; mode = all external; SAK-TC1724F-192F133HL SAK-TC1724F-192F133HR SAK-TC1724N-192F133HR
		–	–	744	mW	power pattern= realistic mode = all external; SAK-TC1724F-192F133HL SAK-TC1724F-192F133HR SAK-TC1724N-192F133HR



تهیه و توزیع قطعات الکترونیک

Electrical Parameters

Table 27 Power Supply Parameters (cont'd)

Parameter	Symbol	Values			Unit	Note / Test Condition
		Min	Typ.	Max.		
Maximum power dissipation	<i>PD</i> CC	–	–	1970	mW	power pattern= max; mode = 5V only with ext. pass device; SAK-TC1724F-192F133HL SAK-TC1724F-192F133HR
		–	–	1950	mW	power pattern= max; mode = 5V only with ext. pass device; SAK-TC1724N-192F133HR
		–	–	1428	mW	power pattern= realistic mode = 5V only with ext. pass device; SAK-TC1724F-192F133HL SAK-TC1724F-192F133HR
		–	–	1403	mW	power pattern= realistic mode = 5V only with ext. pass device; SAK-TC1724N-192F133HR
Maximum power dissipation	<i>PD</i> CC	–	–	810	mW	power pattern= max; mode = all external; SAK-TC1724N-192F80HL SAK-TC1724N-192F80HR
		–	–	669	mW	power pattern= realistic; mode = all external; SAK-TC1724N-192F80HL SAK-TC1724N-192F80HR

تهیه و توزیع قطعات الکترونیک

Electrical Parameters

Table 27 Power Supply Parameters (cont'd)

Parameter	Symbol	Values			Unit	Note / Test Condition
		Min	Typ.	Max.		
Maximum power dissipation	PD CC	–	–	1628	mW	power pattern= max; mode = 5V only without ext. pass device; SAK-TC1724N-192F80HL SAK-TC1724N-192F80HR
		–	–	1200	mW	power pattern= realistic mode = 5V only without ext. pass device; SAK-TC1724N-192F80HL SAK-TC1724N-192F80HR

- 1) Infineon Power Loop: CPU and PCP running, all peripherals active. The power consumption of each customer application will most probably be lower than this value, but must be evaluated separately.
- 2) For operations including the D-Flash the required current is always lower than the current for non-DFlash operations.
- 3) Relevant for the power supply dimensioning, not for thermal considerations.
- 4) In case of erase of Program Flash PF, internal flash array loading effects may generate transient current spikes of up to 15 mA for maximum 5 ms per flash module.

5.2.5.1 Calculating the 1.3 V Current Consumption

The current consumption of the 1.3 V rail compose out of two parts:

- Static current consumption
- Dynamic current consumption

The static current consumption is related to the device temperature T_J and the dynamic current consumption depends of the configured clocking frequencies and the software application executed. These two parts needs to be added in order to get the rail current consumption.

(1)

$$I_0 = 0,674 \left[\frac{\text{mA}}{\text{C}} \right] \times e^{0,02592 \times T_J[\text{C}]}$$

(2)

$$I_0 = 3,9 \left[\frac{\text{mA}}{\text{C}} \right] \times e^{0,02085 \times T_J[\text{C}]}$$

Electrical Parameters

Function 1 defines the typical static current consumption and Function 2 defines the maximum static current consumption. Both functions are valid for $V_{DD} = 1.326 \text{ V}$.

For the dynamic current consumption using the application pattern and $f_{LMB} = f_{PCP} = 2 * f_{FPI}$ the function 4 applies:

(3)

$$I_{Dym} = 0,76 \left[\frac{\text{mA}}{\text{MHz}} \right] \times f_{CPU}[\text{MHz}]$$

For the dynamic current consumption using the application pattern and $f_{LMB} = f_{PCP} = f_{FPI}$ the function 5 applies:

(4)

$$I_{Dym} = 0,9 \left[\frac{\text{mA}}{\text{MHz}} \right] \times f_{CPU}[\text{MHz}]$$

and this finally results in

(5)

$$I_{DD} = I_0 + I_{DYM}$$



تهیه و توزیع قطعات الکترونیک

5.3 AC Parameters

All AC parameters are defined with maximum driver strength unless otherwise stated.

5.3.1 Testing Waveforms

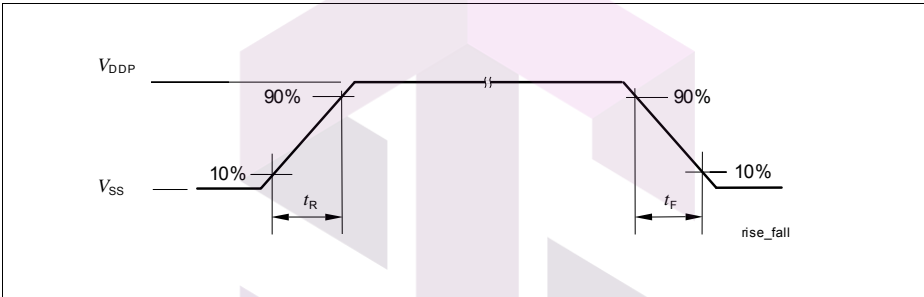

Figure 10 Rise/Fall Time Parameters

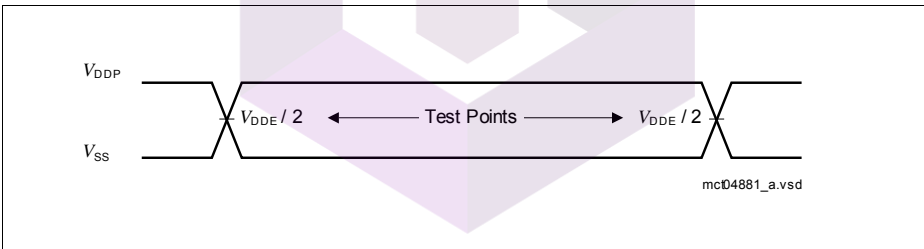

Figure 11 Testing Waveform, Output Delay

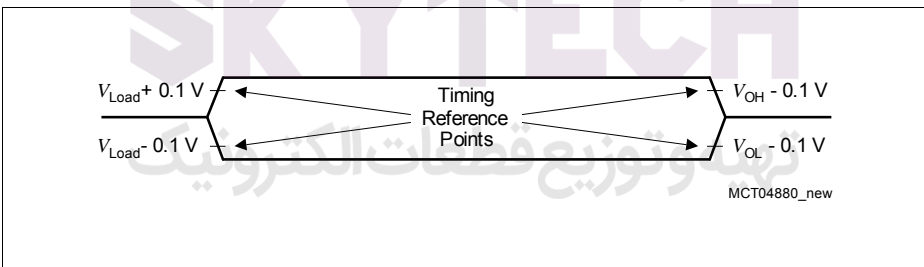

Figure 12 Testing Waveform, Output High Impedance

5.3.2 Power Sequencing 5V Supply Only

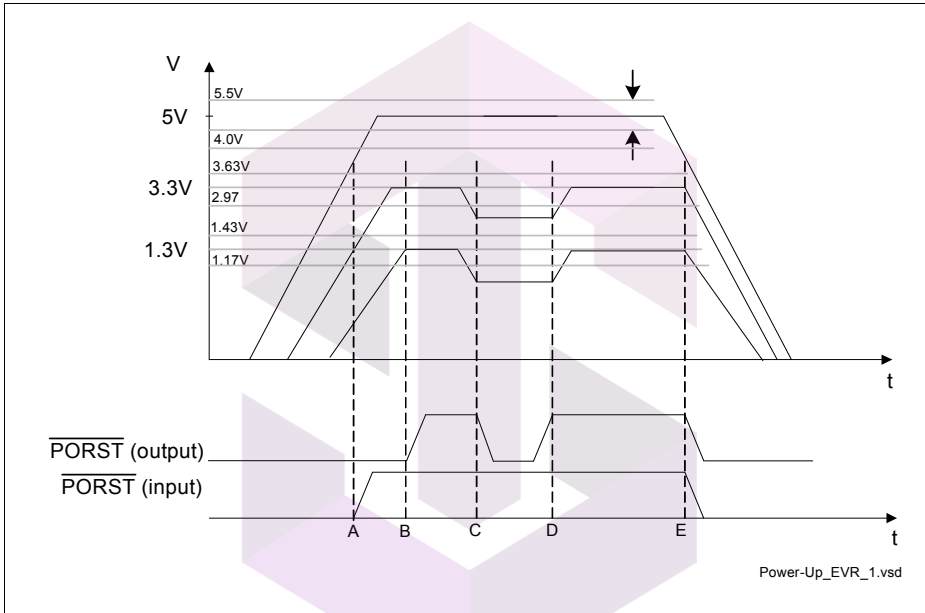

Figure 13 5 V / 3.3 V / 1.3 V Power-Up/Down Sequence

The events for the above points in the power-up/down sequence

- A :external supplied voltage reaches operating level
- B: external supplied and internal generated voltages reaches operating levels
- C: internal generated voltage drops below operating level
- D: internal generated voltage resumes operating level
- E: external supplied voltage leaves operating level

P0.4 and P0.5 should be kept at the selected setting of '0' or '1' until external supplied voltage has reached its operating level.

The following list of rules applies to the power-up/down sequence:

- All ground pins V_{SS} must be externally connected to one single star point in the system. Regarding the DC current component, all ground pins are internally directly connected.
- The latch-up risk is minimized if the I/O currents are limited to:
 - 20 mA for one pin group
 - AND 100 mA for the completed device I/Os

Electrical Parameters

- AND additionally before power-up / after power-down:
 - 1 mA for one pin in inactive mode (0 V on all power supplies)
- The PORST signal may be deactivated after all VDD5, and VAREF0 power-supplies and the oscillator have reached stable operation, within the normal operating conditions.
- At normal power down the PORST signal should be activated within the normal operating range, and then the power supplies may be switched off. Care must be taken that all Flash write or delete sequences have been completed.
- In case of a power-loss at any power-supply, all power supplies must be powered-down, conforming at the same time to the rule number 2.
- Although not necessary, it is additionally recommended that all power supplies are powered-up/down together in a controlled way, as tight to each other as possible.
- Additionally, regarding the ADC reference voltage VAREF0:
 - VAREF0 must power-up at the same time or later then VDDM, and
 - VAREF0 must power-down either earlier or at latest to satisfy the condition $VAREF0 < VDDM + 0.5\text{ V}$. This is required in order to prevent discharge of VAREF0 filter capacitance through the ESD diodes through the VDDM power supply. In case of discharging the reference capacitance through the ESD diodes, the current must be lower than 5 mA.

The SKYTECH logo features the word "SKYTECH" in a large, bold, grey, sans-serif font. The letter 'Y' is stylized with a white arrow pointing upwards from its center.

تهیه و توزیع قطعات الکترونیک

5.3.3 Power Sequencing 3.3V Supply Only

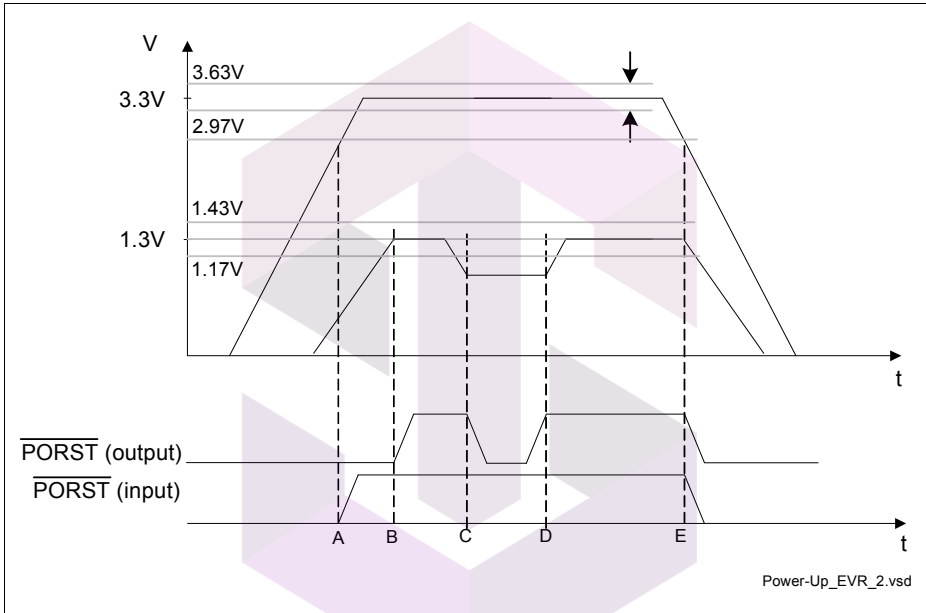

Figure 14 3.3 V / 1.3 V Power-Up/Down Sequence

The events for the above points in the power-up/down sequence

- A :external supplied voltage reaches operating level
- B: external supplied and internal generated voltages reaches operating levels
- C: internal generated voltage drops below operating level
- D: internal generated voltage resumes operating level
- E: external supplied voltage leaves operating level

P0.4 and P0.5 should be kept at the selected setting of '0' or '1' until external supplied voltage has reached its operating level.

The following list of rules applies to the power-up/down sequence:

- All ground pins V_{SS} must be externally connected to one single star point in the system. Regarding the DC current component, all ground pins are internally directly connected.
- The latch-up risk is minimized if the I/O currents are limited to:
 - 20 mA for one pin group
 - AND 100 mA for the completed device I/Os

Electrical Parameters

- AND additionally before power-up / after power-down:
 - 1 mA for one pin in inactive mode (0 V on all power supplies)
- The PORST signal may be deactivated after all VDD3.3, and VAREF0 power-supplies and the oscillator have reached stable operation, within the normal operating conditions.
- At normal power down the PORST signal should be activated within the normal operating range, and then the power supplies may be switched off. Care must be taken that all Flash write or delete sequences have been completed.
- In case of a power-loss at any power-supply, all power supplies must be powered-down, conforming at the same time to the rule number 2.
- Although not necessary, it is additionally recommended that all power supplies are powered-up/down together in a controlled way, as tight to each other as possible.
- Additionally, regarding the ADC reference voltage VAREF0:
 - VAREF0 must power-up at the same time or later then VDDM, and
 - VAREF0 must power-down either earlier or at latest to satisfy the condition $VAREF0 < VDDM + 0.5\text{ V}$. This is required in order to prevent discharge of VAREF0 filter capacitance through the ESD diodes through the VDDM power supply. In case of discharging the reference capacitance through the ESD diodes, the current must be lower than 5 mA.



5.3.4 Power Sequencing all Voltages supplied from External

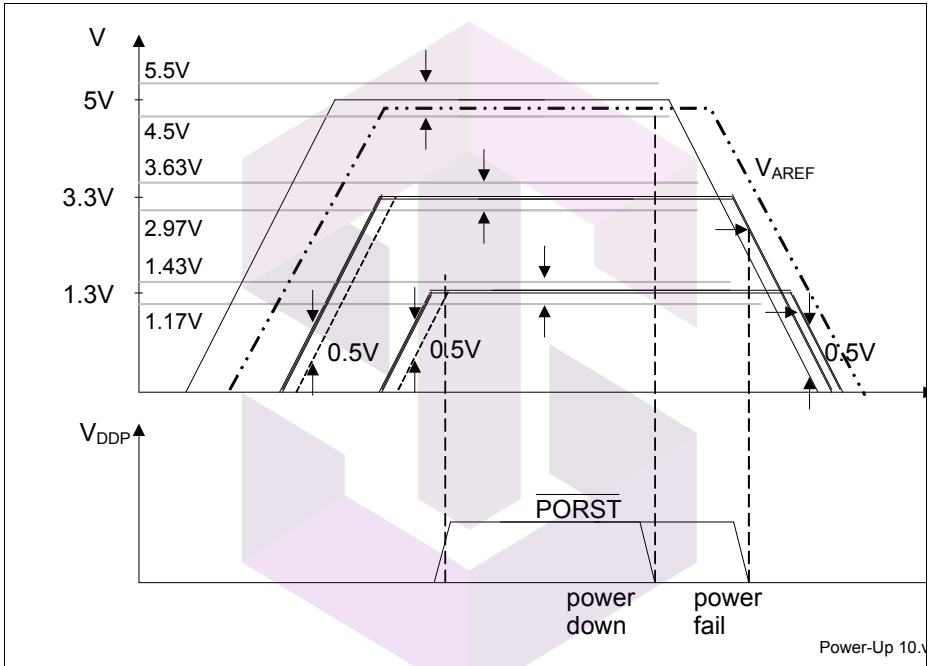

Figure 15 5 V / 3.3 V / 1.3 V Power-Up/Down Sequence

P0.4 and P0.5 should be kept at the selected setting until external supplied voltage has reached its operating level.

The following list of rules applies to the power-up/down sequence:

- All ground pins V_{SS} must be externally connected to one single star point in the system. Regarding the DC current component, all ground pins are internally directly connected.
- At any moment in time to avoid increased latch-up risk, each power supply must be higher than any lower_power_supply - 0.5 V, or: $V_{DD5} > V_{DDP} - 0.5\text{ V}$; $V_{DD5} > V_{DD} - 0.5\text{ V}$; $V_{DDP} > V_{DD} - 0.5\text{ V}$, see [Figure 15](#).
 - The latch-up risk is minimized if the I/O currents are limited to:
 - 20 mA for one pin group
 - AND 100 mA for the completed device I/Os
 - AND additionally before power-up / after power-down:
 - 1 mA for one pin in inactive mode (0 V on all power supplies)

Electrical Parameters

- During power-up and power-down, the voltage difference between the power supply pins of the same voltage (3.3 V, 1.3 V, and 5 V) with different names, that are internally connected via diodes, must be lower than 100 mV. On the other hand, all power supply pins with the same name (for example all VDDP), are internally directly connected. It is recommended that the power pins of the same voltage are driven by a single power supply.
- The PORST signal may be deactivated after all VDD5, VDDP, VDD, and VAREF0 power-supplies and the oscillator have reached stable operation, within the normal operating conditions.
- At normal power down the PORST signal should be activated within the normal operating range, and then the power supplies may be switched off. Care must be taken that all Flash write or delete sequences have been completed.
- At power fail the PORST signal must be activated at latest when any 3.3 V or 1.3 V power supply voltage falls 10% below the nominal level. If, under these conditions, the PORST is activated during a Flash write, only the memory row that was the target of the write at the moment of the power loss will contain unreliable content. In order to ensure clean power-down behavior, the PORST signal should be activated as close as possible to the normal operating voltage range.
- In case of a power-loss at any power-supply, all power supplies must be powered-down, conforming at the same time to the rules number 2 and 4.
- Although not necessary, it is additionally recommended that all power supplies are powered-up/down together in a controlled way, as tight to each other as possible.
- Additionally, regarding the ADC reference voltage VAREF0:
 - VAREF0 must power-up at the same time or later then VDDM, and
 - VAREF0 must power-down either earlier or at latest to satisfy the condition $VAREF0 < VDDM + 0.5 \text{ V}$. This is required in order to prevent discharge of VAREF0 filter capacitance through the ESD diodes through the VDDM power supply. In case of discharging the reference capacitance through the ESD diodes, the current must be lower than 5 mA.



 تهیه و توزیع قطعات الکترونیک

5.3.5 Power, Pad and Reset Timing

Table 28 Reset Timings Parameters

Parameter	Symbol	Values			Unit	Note / Test Condition
		Min.	Typ.	Max.		
Application Reset Boot Time ⁽¹⁾⁽²⁾	t_B CC	150	–	810	μs	SAK-TC1724F-192F133HL SAK-TC1724F-192F133HR SAK-TC1724N-192F133HR
		150	–	1140	μs	SAK-TC1724N-192F80HL SAK-TC1724N-192F80HR
Power on Reset Boot Time ⁽³⁾⁽⁴⁾	t_{BP} CC	–	–	2.5	ms	
EVR Startup time from Supply ramp-up till PORST release	t_{EVR} CC	–	860	1100	μs	
HWCFG pins hold time from ESR0 rising edge	t_{HDH} SR	$16 / f_{FPI}$	–	–	ns	
HWCFG pins setup time to ESR0 rising edge	t_{HDS} CC	0	–	–	ns	
Ports inactive after ESR0 reset active	t_{PI} CC	–	–	$8 / f_{FPI}$	ns	
Ports inactive after PORST reset active ⁽⁵⁾	t_{PIP} CC	–	–	150	ns	
Minimum PORST active time after power supplies are stable at operating levels	t_{POA} CC	4.5	–	–	ms	⁽⁶⁾

Electrical Parameters

Table 28 Reset Timings Parameters (cont'd)

Parameter	Symbol	Values			Unit	Note / Test Condition
		Min.	Typ.	Max.		
$\overline{\text{TESTMODE}} / \overline{\text{TRST}}$ hold time from PORST rising edge	$t_{\text{POH SR}}$	100	–	–	ns	
PORST rise time	$t_{\text{POR SR}}$	–	–	50	ms	
$\overline{\text{TESTMODE}} / \overline{\text{TRST}}$ setup time to PORST rising edge	$t_{\text{POS SR}}$	0	–	–	ns	
Application Reset inactive after PORST deassertion	$t_{\text{POR_APP SR}}$	–	–	40 ⁷⁾	μs	

- 1) The duration of the boot time is defined between the rising edge of the internal application reset and the clock cycle when the first user instruction has entered the CPU pipeline and its processing starts.
- 2) The given time includes the time of the internal reset extension for a configured value of SCU_RSTCNTCON.RELSA = 0x05BE.
- 3) The duration of the boot time is defined between the rising edge of the $\overline{\text{PORST}}$ and the clock cycle when the first user instruction has entered the CPU pipeline and its processing starts.
- 4) The given time includes the internal reset extension time for the System and Application Reset which is visible through ESR0.
- 5) This parameter includes the delay of the analog spike filter in the $\overline{\text{PORST}}$ pad.
- 6) This parameter represents the additional time required to ensure that external crystal is stable and operational at $\overline{\text{PORST}}$.
- 7) Application Reset is assumed not to be extended from external, otherwise the time extends by the time the Application Reset is extended.

تهیه و توزیع قطعات الکترونیک

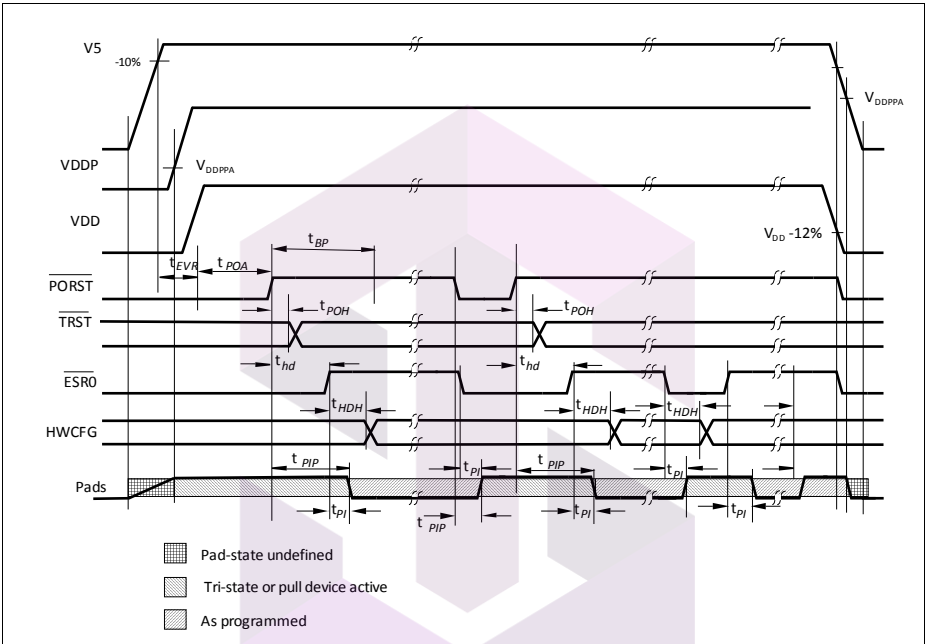

Figure 16 Power, Pad and Reset Timing

SKYTECH

تهیه و توزیع قطعات الکترونیک

5.3.6 EVR Parameter

Table 29 Pass device detector

Parameter	Symbol	Values			Unit	Note / Test Condition
		Min.	Typ.	Max.		
Pull-up current at VDPG	I_{PU_VDPG} SR	0.7	–	2.0	mA	$V_{DD5} \geq 4.5V$; $V_{DD5} \leq 5.5V$
Input low voltage	V_{IL} SR	0	–	1.5	V	

Table 30 EVR Parameters

Parameter	Symbol	Values			Unit	Note / Test Condition
		Min.	Typ.	Max.		
Output Capacitance on V_{DDP}	C_{OUT33} CC	–	6.8	–	μF	$I_{LOAD} > 310$ mA; ESR < 50m Ω ; with external pass device, additional decoupling capacitor on each supply pin, SAK-TC1724F-192F133HL SAK-TC1724F-192F133HR SAK-TC1724N-192F133HR
		–	2.2	–	μF	$I_{LOAD} \leq 310$ mA; ESR < 50m Ω ; with internal pass device, additional decoupling capacitor on each supply pin, SAK-TC1724N-192F80HL SAK-TC1724N-192F80HR

تهیه و توزیع قطعات الکترونیک

Electrical Parameters

Table 30 EVR Parameters (cont'd)

Parameter	Symbol	Values			Unit	Note / Test Condition
		Min.	Typ.	Max.		
Output Capacitance on V_{DD}	C_{OUT13} CC	-	6.8	-	μF	$I_{LOAD} < 250 \text{ mA}$; ESR < 50m Ω ; additional decoupling capacitor on each supply pin, SAK-TC1724F-192F133HL SAK-TC1724F-192F133HR SAK-TC1724N-192F133HR
		-	4.7	-	μF	$I_{LOAD} < 250 \text{ mA}$; ESR < 50m Ω ; additional decoupling capacitor on each supply pin, SAK-TC1724N-192F80HL SAK-TC1724N-192F80HR
Input Capacitance on V_5	C_{IN5} CC	-	6.8	-	μF	depending on ext. regulator SAK-TC1724F-192F133HL SAK-TC1724F-192F133HR SAK-TC1724N-192F133HR
		-	4.7	-	μF	depending on ext. regulator SAK-TC1724N-192F80HL SAK-TC1724N-192F80HR
Undervoltage Reset threshold for external supply	V_{RST5} CC	-	-	2.97	V	3.3V single supply
		-	-	4.5	V	5.0 single supply
Output accuracy of EVR33 after trimming	ΔV_{OUT33} CC	-80	-	+80	mV	$4.5\text{V} \leq V_{IN} \leq 5.5\text{V}$; $1 \text{ mA} \leq I_{OUT} \leq 310\text{mA}$
Dynamic Load Regulation of EVR33	ΔV_{LOREG} 33 CC	-225	-	+225	mV	$dl / dt = 150\text{mA} / 10 \text{ ns}$
Dynamic Line Regulation of EVR33	ΔV_{LIREG} 33 CC	-25	-	+25	mV	$dV5 / dt = 1\text{V} / \text{ms}$ 1 ... 310mA, 4.5V ... 5.5V

Electrical Parameters

Table 30 EVR Parameters (cont'd)

Parameter	Symbol	Values			Unit	Note / Test Condition
		Min.	Typ.	Max.		
Undervoltage Reset threshold for EVR33	V_{RST33} CC	–	–	2.97	V	
Current drawn from EVR33 for external devices with internal pass devices.	EXI_{33} SR	–	–	30	mA	No inductive loads allowed. Decoupling capacitor > 330 nF
Output accuracy of EVR13 after trimming	ΔV_{OUT13} CC	-30	–	+30	mV	$2.97V \leq V_{IN} \leq 3.63V$; $1 \text{ mA} \leq I_{OUT} \leq 250\text{mA}$
Dynamic Load Regulation of EVR13	ΔV_{LOREG} 13 CC	-100	–	+100	mV	5.0V/3.3V single supply, $dI / dt = 150\text{mA} / 10 \text{ ns}$
Dynamic Line Regulation of EVR13	ΔV_{LIREG} 13 CC	-10	–	+10	mV	5.0V/3.3V single supply, $dV5 / dt = 1V / \text{ms}$ 1 ... 250mA, 2.97V ... 3.63V
Undervoltage Reset threshold for EVR13	V_{RST13} CC	–	–	1.17	V	
Current drawn from EVR13 for external devices	EXI_{13} SR	–	–	10	mA	No inductive loads allowed. Decoupling capacitor > 100 nF
Supply ramp-up	SR SR	–	–	50	V/ms	

تهیه و توزیع قطعات الکترونیک

5.3.7 Phase Locked Loop (PLL)

Table 31 PLL_SysClk Parameters

Parameter	Symbol		Values			Unit	Note / Test Condition
			Min.	Typ.	Max.		
Accumulated Jitter	D_P	CC	-7	-	7	ns	
PLL base frequency	$f_{PLLBASE}$	CC	50	200	320	MHz	
VCO input frequency	f_{REF}	CC	8	-	16	MHz	
VCO frequency range	f_{VCO}	CC	400	-	720	MHz	
PLL lock-in time	t_L	CC	14	-	200	μ s	N > 32
			14	-	400	μ s	N \leq 32

Phase Locked Loop Operation

When PLL operation is enabled and configured, the PLL clock f_{VCO} (and with it the LMB-Bus clock f_{LMB}) is constantly adjusted to the selected frequency. The PLL is constantly adjusting its output frequency to correspond to the input frequency (from crystal or clock source), resulting in an accumulated jitter that is limited. This means that the relative deviation for periods of more than one clock cycle is lower than for a single clock cycle.

This is especially important for bus cycles using wait states and for the operation of timers, serial interfaces, etc. For all slower operations and longer periods (e.g. pulse train generation or measurement, lower baudrates, etc.) the deviation caused by the PLL jitter is negligible.

Two formulas are defined for the (absolute) approximate maximum value of jitter D_m in [ns] dependent on the K2 - factor, the LMB clock frequency f_{LMB} in [MHz], and the number m of consecutive f_{LMB} clock periods.

$$|D_m[\text{ns}]| = \left(\frac{740}{K2 \times f_{LMB}[\text{MHz}]} + 5 \right) \times \left(\frac{(1 - 0,01 \times K2) \times (m - 1)}{0,5 \times f_{LMB}[\text{MHz}] - 1} + 0,01 \times K2 \right) \quad (6)$$

$$\text{else} \quad |D_m[\text{ns}]| = \frac{740}{K2 \times f_{LMB}[\text{MHz}]} + 5 \quad (7)$$

Electrical Parameters

With rising number m of clock cycles the maximum jitter increases linearly up to a value of m that is defined by the K2-factor of the PLL. Beyond this value of m the maximum accumulated jitter remains at a constant value. Further, a lower LMB-Bus clock frequency f_{LMB} results in a higher absolute maximum jitter value.

Note: The specified PLL jitter values are valid if the capacitive load per pin does not exceed $C_L = 20$ pF with the maximum driver and sharp edge.

Oscillator Watchdog (OSC_WDT)

The expected input frequency is selected via the bit field SCU_OSCCON.OSCVAL. The OSC_WDT checks for too low frequencies and for too high frequencies.

The frequency that is monitored is f_{OSCREF} which is derived for f_{OSC} .

$$f_{OSCREF} = \frac{f_{OSC}}{OSCVAL + 1} \quad (8)$$

The divider value SCU_OSCCON.OSCVAL has to be selected in a way that f_{OSCREF} is 2.5 MHz.

Note: f_{OSCREF} has to be within the range of 2 MHz to 3 MHz and should be as close as possible to 2.5 MHz.

The monitored frequency is too low if it is below 1.25 MHz and too high if it is above 7.5 MHz. This leads to the following two conditions:

- Too low: $f_{OSC} < 1.25 \text{ MHz} \times (\text{SCU_OSCCON.OSCVAL} + 1)$
- Too high: $f_{OSC} > 7.5 \text{ MHz} \times (\text{SCU_OSCCON.OSCVAL} + 1)$

Note: The accuracy is 30% for these boundaries.



5.3.8 ERAY Phase Locked Loop (ERAY_PLL)

Table 32 PLL_ERAY Parameters

Parameter	Symbol		Values			Unit	Note / Test Condition
			Min.	Typ.	Max.		
Accumulated jitter at SYSCLK pin	D_{pp}	CC	-0.8	–	0.8	ns	
Accumulated_Jitter	D_p	CC	-0.5	–	0.5	ns	
PLL Base Frequency of the ERAY PLL	$f_{PLLBASE_ERAY}$	CC	50	250	360	MHz	
VCO input frequency of the ERAY PLL	f_{REF}	CC	20	–	40	MHz	
VCO frequency range of the ERAY PLL	f_{VCO_ERAY}	CC	450	–	500	MHz	
PLL lock-in time	t_L	CC	5.6	–	200	μ s	

Note: The specified PLL jitter values are valid if the capacitive load per pin does not exceed $C_L = 20$ pF with the maximum driver and sharp edge.



 تهیه و توزیع قطعات الکترونیک

5.3.9 JTAG Interface Timing

The following parameters are applicable for communication through the JTAG debug interface. The JTAG module is fully compliant with IEEE1149.1-2000.

Note: These parameters are not subject to production test but verified by design and/or characterization.

Table 33 JTAG Parameters

Parameter	Symbol	Values			Unit	Note / Test Condition
		Min.	Typ.	Max.		
TCK clock period	t_1 SR	25	–	–	ns	
TCK high time	t_2 SR	10	–	–	ns	
TCK low time	t_3 SR	10	–	–	ns	
TCK clock rise time	t_4 SR	–	–	4	ns	
TCK clock fall time	t_5 SR	–	–	4	ns	
TDI/TMS setup to TCK rising edge	t_6 SR	6.0	–	–	ns	
TDI/TMS hold after TCK rising edge	t_7 SR	6.0	–	–	ns	
TDO valid after TCK falling edge ¹⁾	t_8 CC	3.0	–	–	ns	$C_L = 20$ pF
		–	–	13	ns	$C_L = 50$ pF
TDO high impedance to valid from TCK falling edge ²⁾	t_9 CC	–	–	14	ns	$C_L = 50$ pF
TDO valid output to high impedance from TCK falling edge	t_{10} CC	–	–	13.5	ns	$C_L = 50$ pF
TDO hold after TCK falling edge	t_{18} CC	2	–	–	ns	

1) The falling edge on TCK is used to generate the TDO timing.

2) The setup time for TDO is given implicitly by the TCK cycle time.

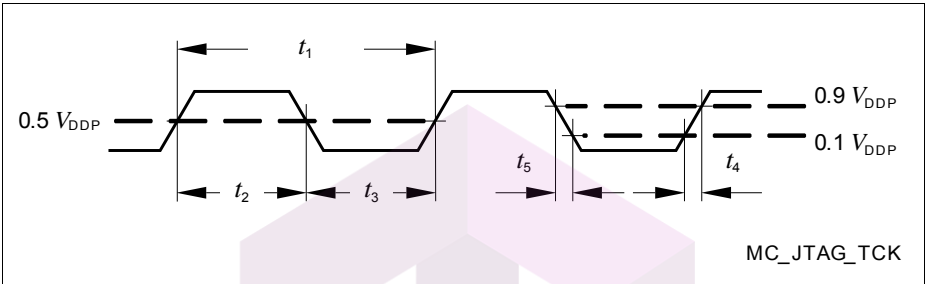

Figure 17 Test Clock Timing (TCK)

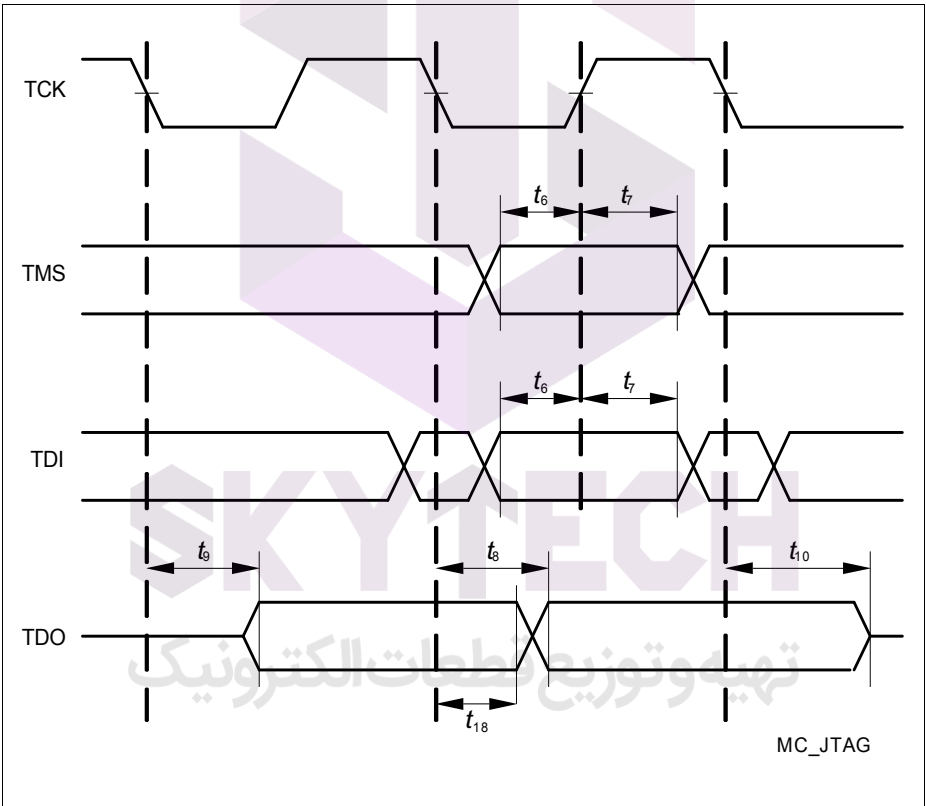

Figure 18 JTAG Timing

5.3.10 DAP Interface Timing

The following parameters are applicable for communication through the DAP debug interface.

Note: These parameters are not subject to production test but verified by design and/or characterization.

Table 34 DAP Parameters

Parameter	Symbol	Values			Unit	Note / Test Condition
		Min.	Typ.	Max.		
DAP0 clock period ¹⁾	t_{TCK} SR	12.5	–	–	ns	
DAP0 high time	t_{12} SR	4	–	–	ns	
DAP0 low time ¹⁾	t_{13} SR	4	–	–	ns	
DAP0 clock rise time	t_{14} SR	–	–	2	ns	
DAP0 clock fall time	t_{15} SR	–	–	2	ns	
DAP1 setup to DAP0 rising edge	t_{16} SR	6.0	–	–	ns	
DAP1 hold after DAP0 rising edge	t_{17} SR	6.0	–	–	ns	
DAP1 valid per DAP0 clock period ²⁾	t_{19} CC	8	–	–	ns	$C_L = 20$ pF; $f = 80$ MHz
		10	–	–	ns	$C_L = 50$ pF; $f = 40$ MHz

1) See the DAP chapter for clock rate restrictions in the Active::IDLE protocol state.

2) The Host has to find a suitable sampling point by analyzing the sync telegram response.

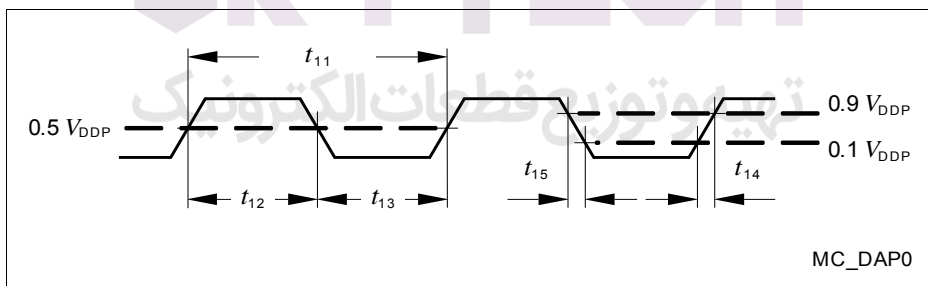

Figure 19 Test Clock Timing (DAP0)

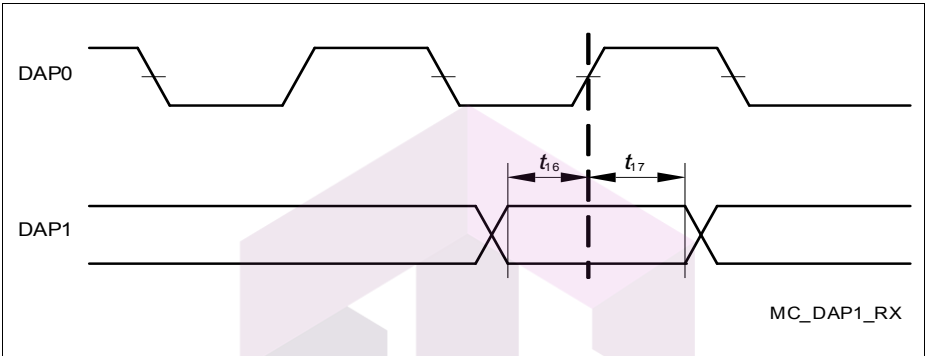

Figure 20 DAP Timing Host to Device

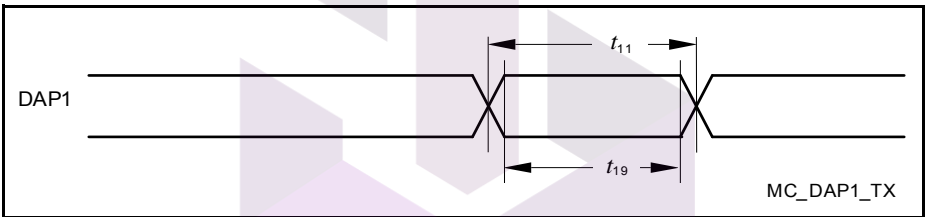

Figure 21 DAP Timing Device to Host

SKYTECH

تهیه و توزیع قطعات الکترونیک

5.3.11 Peripheral Timings

Note: Peripheral timings are not subjected to production test. They are verified by design / characterization.

5.3.11.1 Micro Link Interface (MLI) Timing

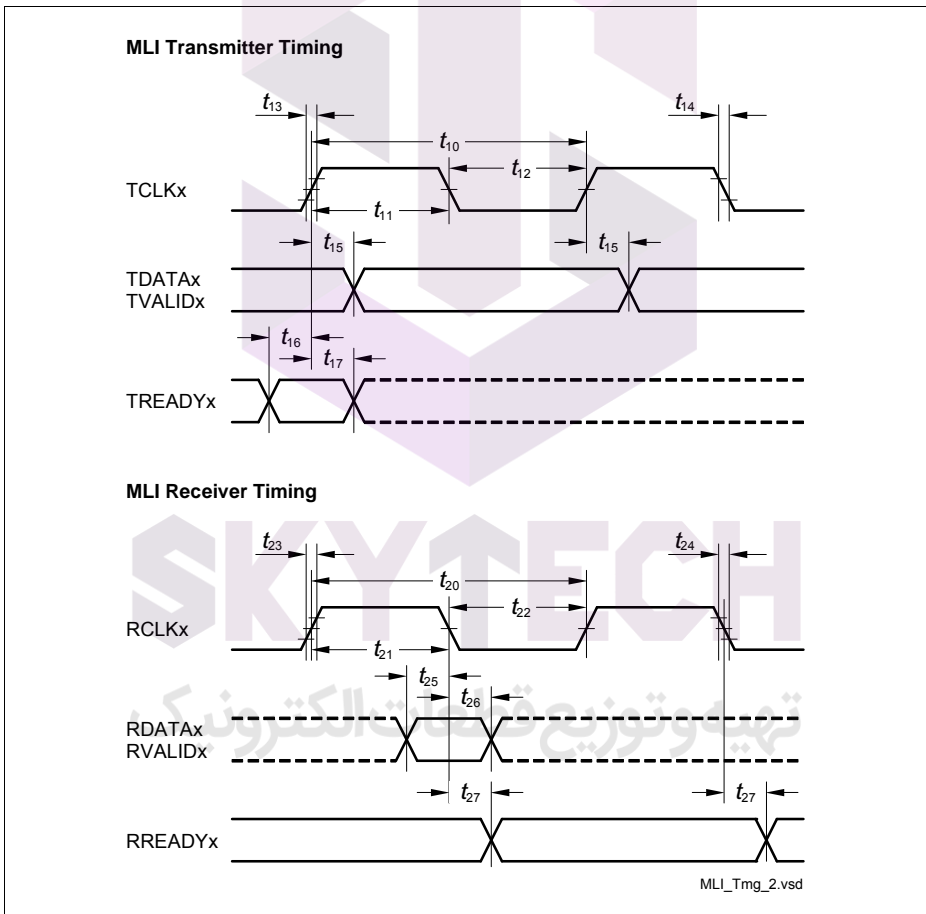

Figure 22 MLI Interface Timing

Electrical Parameters

Note: The generation of RREADY_x is in the input clock domain of the receiver. The reception of TREADY_x is asynchronous to TCLK_x.

The MLI parameters are valid for C_L = 50 pF, strong driver medium edge.

Table 35 MLI Receiver

Parameter	Symbol	Values			Unit	Note / Test Condition
		Min.	Typ.	Max.		
RCLK clock period	t_{20} SR	$1 / f_{FPI}$	–	–	ns	
RCLK high time ¹⁾²⁾	t_{21} SR	–	$0.5 \times t_{20}$	–	ns	
RCLK low time ¹⁾²⁾	t_{22} SR	–	$0.5 \times t_{20}$	–	ns	
RCLK rise time ³⁾	t_{23} SR	–	–	4	ns	
RCLK fall time ³⁾	t_{24} SR	–	–	4	ns	
RDATA/RVALID setup time before RCLK falling edge	t_{25} SR	4.2	–	–	ns	
RDATA/RVALID hold time after RCLK falling edge	t_{26} SR	2.2	–	–	ns	
RREADY output delay time	t_{27} SR	0	–	16	ns	

1) The following formula is valid: $t_{21} + t_{22} = t_{20}$.

2) Min and Max values for this parameter can be derived from the typ. value by considering the other receiver timing parameters.

3) The RCLK max. input rise/fall times are best case parameters for f_{FPI}max. For reduction of EMI, slower input signal rise/fall times can be used for longer RCLK clock periods.

Table 36 MLI Transmitter

Parameter	Symbol	Values			Unit	Note / Test Condition
		Min.	Typ.	Max.		
TCLK clock period	t_{10} CC	$2 \times 1 / f_{FPI}$	–	–	ns	
TCLK high time ¹⁾²⁾	t_{11} CC	$0.45 \times t_{10}$	$0.5 \times t_{10}$	$0.55 \times t_{10}$	ns	
TCLK low time ¹⁾²⁾	t_{12} CC	$0.45 \times t_{10}$	$0.5 \times t_{10}$	$0.55 \times t_{10}$	ns	

Electrical Parameters

Table 36 MLI Transmitter (cont'd)

Parameter	Symbol	Values			Unit	Note / Test Condition
		Min.	Typ.	Max.		
TCLK rise time	t_{13} CC	–	–	$0.3 \times t_{10}^{3)}$	ns	
TCLK fall time	t_{14} CC	–	–	$0.3 \times t_{10}^{3)}$	ns	
TDATA/TVALID output delay time	t_{15} CC	-3	–	4.4	ns	
TREADY setup time before TCLK rising edge	t_{16} SR	18	–	–	ns	
TREADY hold time after TCLK rising edge	t_{17} SR	-2	–	–	ns	

1) The following formula is valid: $t_{11} + t_{12} = t_{10}$.

2) The min./max. TCLK low/high times t_{11}/t_{12} include the PLL jitter of f_{SYS} . Fractional divider settings must be regarded additionally to t_{11} / t_{12} .

3) For high-speed MLI interface, strong driver sharp or medium edge selection (class A2 pad) is recommended for TCLK.

5.3.11.2 Micro Second Channel (MSC) Interface Timing

The MSC parameters are valid for $C_L = 50$ pF.

Table 37 MSC Parameters

Parameter	Symbol	Values			Unit	Note / Test Condition
		Min.	Typ.	Max.		
FCLP clock period ¹⁾²⁾	t_{40} CC	$2 \times T_{MSC}^{3)}$	–	–	ns	

تهیه و توزیع قطعات الکترونیک

Electrical Parameters

Table 37 MSC Parameters (cont'd)

Parameter	Symbol	Values			Unit	Note / Test Condition
		Min.	Typ.	Max.		
SOP ⁴⁾ /ENx outputs delay from FCLP ⁴⁾ rising edge	t_{45} CC	-5	—	5	ns	ENx with strong driver and sharp (minus) edge; CMOS mode
		-2	—	10	ns	ENx with strong driver and medium (minus) edge
		0	—	21	ns	ENx with strong driver and soft edge
SDI bit time	t_{46} CC	8 x T_{MSC}	—	—	ns	
SDI rise time	t_{48} SR	—	—	200	ns	
SDI fall time	t_{49} SR	—	—	200	ns	

- 1) FCLP signal rise/fall times are only defined by the pad rise/fall times.
- 2) FCLP signal high and low can be minimum 1 / T_{MSC}
- 3) $T_{MSC} = T_{SYS} = 1 / f_{SYS}$.
- 4) SOP / FCLP either propagated by CMOS strong driver and non soft edge.

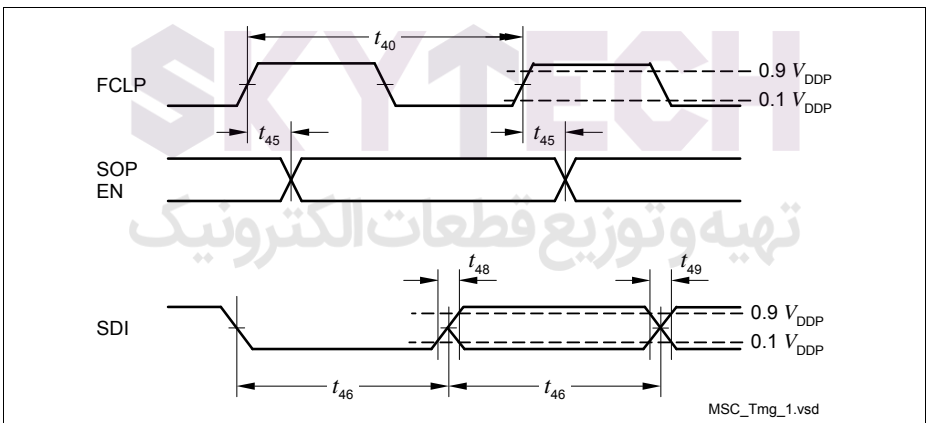

Figure 23 MSC Interface Timing

Electrical Parameters

Note: The data at SOP should be sampled with the falling edge of FCLP in the target device.

**SKYTECH**

تهیه و توزیع قطعات الکترونیک

5.3.11.3 SSC Master/Slave Mode Timing

The SSC parameters are valid for $C_L = 50$ pF, strong driver medium edge.

Table 38 Parameters

Parameter	Symbol	Values			Unit	Note / Test Condition
		Min.	Typ.	Max.		
SCLK clock period ¹⁾²⁾³⁾	t_{50} CC	$2 \times 1 / f_{FPI}$	–	–	ns	
MTSR/SLSOx delay from SCLK rising edge	t_{51} CC	0	–	8	ns	
MRST setup to SCLK latching edge ³⁾	t_{52} SR	16.5	–	–	ns	
MRST hold from SCLK latching edge ³⁾	t_{53} SR	0	–	–	ns	
SCLK input clock period ¹⁾³⁾	t_{54} SR	$4 \times 1 / f_{FPI}$	–	–	ns	
SCLK input clock duty cycle	$t_{55_t_{54}}$ SR	45	–	55	%	
MTSR setup to SCLK latching edge ³⁾⁴⁾	t_{56} SR	$1 / f_{FPI} + 1$	–	–	ns	
MTSR hold from SCLK latching edge	t_{57} SR	$1 / f_{FPI} + 5$	–	–	ns	
SLSI setup to first SCLK latching edge	t_{58} SR	$1 / f_{FPI} + 5$	–	–	ns	
SLSI hold from last SCLK latching edge ⁵⁾	t_{59} SR	7	–	–	ns	
MRST delay from SCLK shift edge	t_{60} CC	0	–	16.5	ns	
SLSI to valid data on MRST	t_{61} CC	–	–	16.5	ns	

1) SCLK signal rise/fall times are the same as the rise/fall times of the pad.

2) SCLK signal high and low times can be minimum 1xT.

3) $T_{min} = T_{SYS} = 1/f_{SYS}$.

4) Fractional divider switched off, internal baud rate generation used.

Electrical Parameters

- 5) For CON.PH=1 slave select must not be removed before the following shifting edge. This mean, that what ever is configured (shifting / latching first), SLSI must not be de-activated before the last trailing edge from the pair of shifting / latching edges.

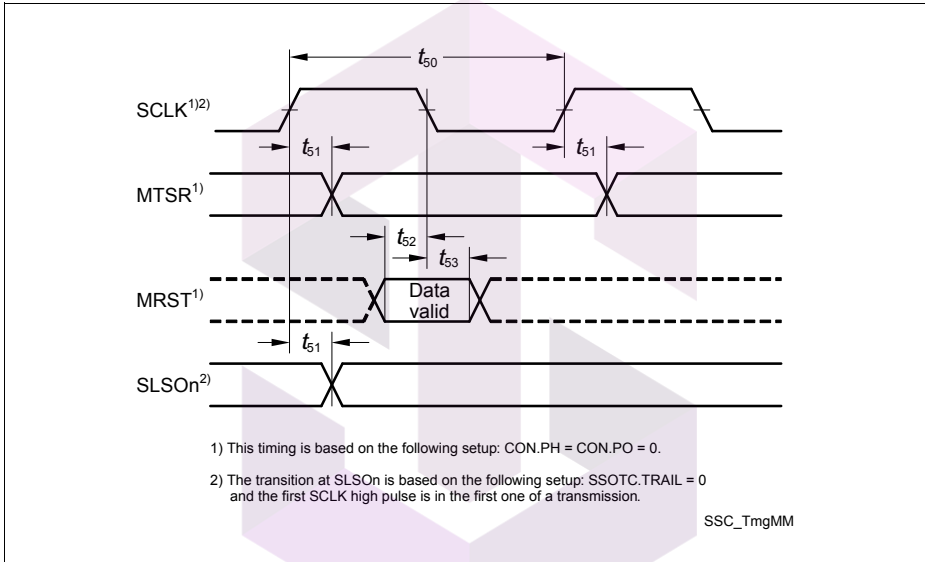

Figure 24 Master Mode Timing



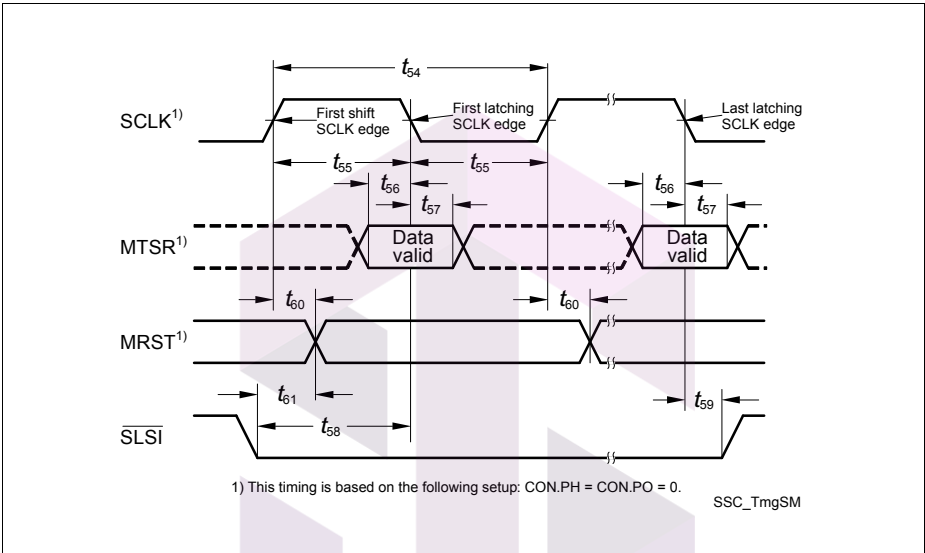

Figure 25 Slave Mode Timing

SKYTECH

تهیه و توزیع قطعات الکترونیک

5.3.11.4 ERAY Interface Timing

The timings of this section are valid for the strong driver and either sharp edge or medium edge settings of the output drivers with $C_L = 25 \text{ pF}$.

The ERAY interface is only available for the SAK-TC1724F-192F133HL and SAK-TC1724F-192F133HR.

Table 39 ERAY Parameters

Parameter	Symbol	Values			Unit	Note / Test Condition
		Min.	Typ.	Max.		
Time span from last BSS to FES without the influence of quartz tolerancies (d10Bit_TX) ¹⁾	t_{60} CC	997.75	–	1002.25	ns	
TxD data valid from fsample flip flop txd_reg TxDA, TxDB (dTxAsym) ²⁾³⁾	t_{61} - t_{62} CC	–	–	1.5	ns	Asymmetrical delay of rising and falling edge (TxDA, TxDB)
Time span between last BSS and FES without influence of quartz tolerancies (d10Bit_RX) ¹⁾⁴⁾⁵⁾	t_{63} SR	966	–	1046.1	ns	
RxD capture by fsample (RxDA/RxDB sampling flip-flop) (dRxAsym) ⁵⁾	t_{64} - t_{65} CC	–	–	3.0	ns	Asymmetrical delay of rising and falling edge (RxDA, RxDB)
TxD data delay from sampling flip-flop	$dTxdly$ CC	–	–	10.0	ns	Px_PDRz.PDy = 000 _B
		–	–	15.0	ns	Px_PDRz.PDy = 001 _B
RxD capture delay by sampling flip-flop	$dRxdly$ CC	–	–	10.0	ns	

1) This includes the PLL_ERAY accumulated jitter.

2) Refers to delays caused by the asymmetries of the output drivers of the digital logic and the GPIO pad drivers. Quartz tolerance and PLL_ERAY accumulated jitter are not included.

3) E-Ray TxD output drivers have an asymmetry of rising and falling edges of $|t_{FA2} - t_{RA2}| \leq 1 \text{ ns}$.

4) Limits of 966ns and 1046.1ns correspond to (30%, 70%) * V_{DDP} FlexRay standard input thresholds. For input thresholds of this product, a correction of - 0.5 ns and +0.1 ns has to be applied.

Electrical Parameters

- 5) Valid for output slopes of the bus driver of dRxSlope 5ns, 20% * V_{DDP} to 80% * V_{DDP} , according to the FlexRay Electrical Physical Layer Specification V2.1B. For A2 pads, the rise and fall times of the incoming signal have to satisfy the following inequality: $-1.6ns \leq |t_{FA2} - t_{RA2}| \leq 1.3ns$.

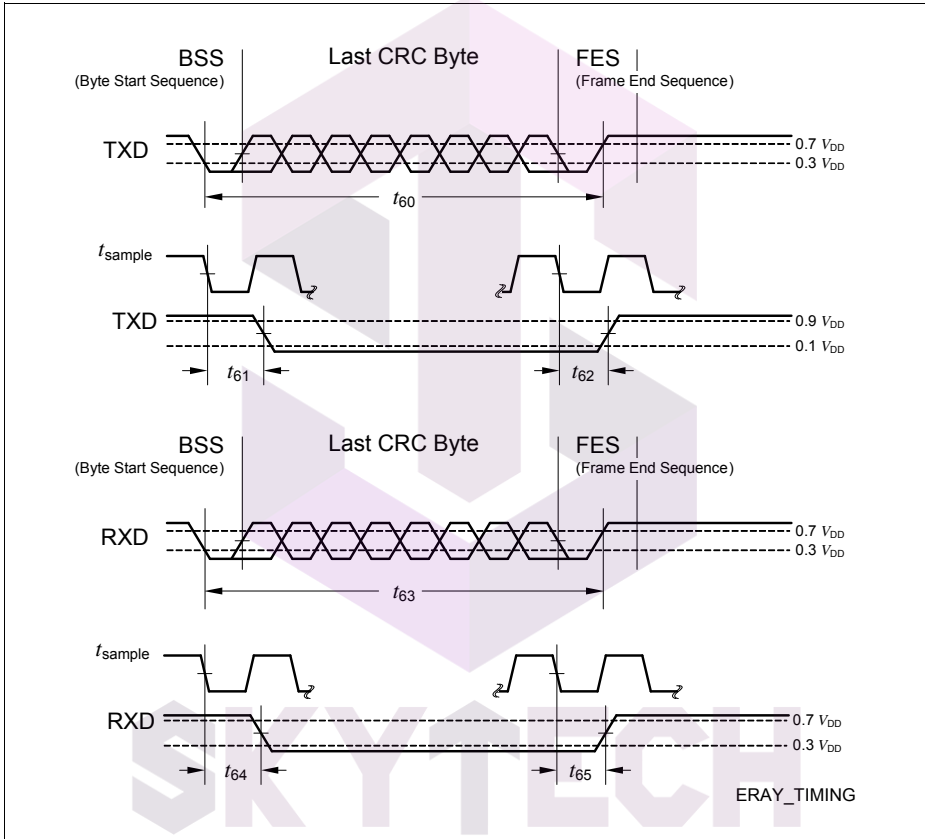

Figure 26 ERAY Timing

تهیه و توزیع قطعات الکترونیک

5.4 Package and Reliability

5.4.1 Package Parameters

Table 40 Thermal Characteristics of the Package

Device	Package	$R_{\Theta JCT}$ 1)	$R_{\Theta JC}$ B ¹⁾	$R_{\Theta JCL}$ 1)	Unit	Note
TC1724	PG-LQFP-144-17	9.0	0.4	28.1	K/W	

1) The top and bottom thermal resistances between the case and the ambient ($R_{T_{CAT}}$, $R_{T_{CAB}}$) are to be combined with the thermal resistances between the junction and the case given above ($R_{T_{JCT}}$, $R_{T_{JCB}}$), in order to calculate the total thermal resistance between the junction and the ambient ($R_{T_{JA}}$). The thermal resistances between the case and the ambient ($R_{T_{CAT}}$, $R_{T_{CAB}}$) depend on the external system (PCB, case) characteristics, and are under user responsibility.

The junction temperature can be calculated using the following equation: $T_J = T_A + R_{T_{JA}} \times P_D$, where the $R_{T_{JA}}$ is the total thermal resistance between the junction and the ambient. This total junction ambient resistance $R_{T_{JA}}$ can be obtained from the upper four partial thermal resistances.



 تهیه و توزیع قطعات الکترونیک

5.4.2 Package Outline

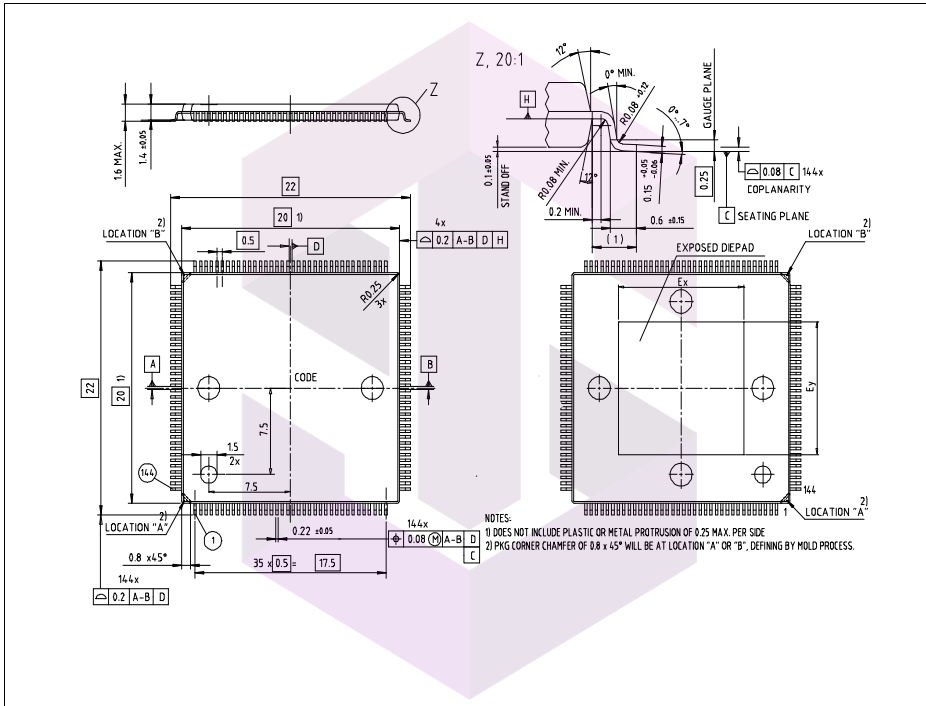

Figure 27 Package Outlines PG-LQFP-144-17

Table 41 Exposed pad Dimensions

Ex	7.5 mm
Ey	7.5 mm

You can find all of our packages, sorts of packing and others in our Infineon Internet Page "Products": <http://www.infineon.com/products>.

5.4.3 Flash Memory Parameters

The data retention time of the TC1724's Flash memory depends on the number of times the Flash memory has been erased and programmed.

Electrical Parameters

Table 42 FLASH32 Parameters

Parameter	Symbol		Values			Unit	Note / Test Condition
			Min.	Typ.	Max.		
Data Flash Erase Time per Sector	t_{ERD}	CC	–	–	3 ¹⁾	s	
Program Flash Erase Time per 256 KByte Sector	t_{ERP}	CC	–	–	5	s	
Program time data flash per page ²⁾	t_{PRD}	CC	–	–	5.3	ms	without reprogramming
			–	–	15.9	ms	with two reprogramming cycles
Program time program flash per page ³⁾	t_{PRP}	CC	–	–	5.3	ms	without reprogramming
			–	–	10.6	ms	with one reprogramming cycle
Data Flash Endurance	N_E	CC	60000 ⁴⁾	–	–	cycles	Min. data retention 5 years
Erase suspend delay	t_{FL_ErSusp}	CC	–	–	15	ms	
Wait time after margin change	$t_{FL_MarginDel}$	SR	10	–	–	μs	
Program Flash Retention Time, Physical Sector ⁵⁾⁶⁾	t_{RET}	CC	20	–	–	years	Max. 1000 erase/program cycles
Program Flash Retention Time, Logical Sector ⁵⁾⁶⁾	t_{RETL}	CC	20	–	–	years	Max. 100 erase/program cycles
UCB Retention Time ⁵⁾⁶⁾	t_{RTU}	CC	20	–	–	years	Max. 4 erase/program cycles per UCB
Wake-Up time ²⁾	t_{WU}	CC	–	–	270	μs	

Electrical Parameters

Table 42 FLASH32 Parameters (cont'd)

Parameter	Symbol		Values			Unit	Note / Test Condition
			Min.	Typ.	Max.		
DFlash wait state configuration	WS_{DF}	SR	$50ns \times f_{LMB}$	–	–		
PFlash wait state configuration	WS_{PF}	SR	$26ns \times f_{LMB}$	–	–		

- 1) In case of wordline oriented defects (see robust EEPROM emulation in the User's Manual) this erase time can increase by up to 100%.
- 2) In case the Program Verify feature detects weak bits, these bits will be programmed up to twice more. Each reprogramming takes additional 5 ms.
- 3) In case the Program Verify feature detects weak bits, these bits will be programmed once more. The reprogramming takes additional 5 ms.
- 4) Only valid when a robust EEPROM emulation algorithm is used. For more details see the User's Manual.
- 5) Storage and inactive time included.
- 6) At average weighted junction temperature $T_j = 100^\circ\text{C}$, or the retention time at average weighted temperature of $T_j = 110^\circ\text{C}$ is minimum 10 years, or the retention time at average weighted temperature of $T_j = 150^\circ\text{C}$ is minimum 0.7 years.

5.4.4 Quality Declarations

Table 43 Quality Parameters

Parameter	Symbol	Values			Unit	Note / Test Condition
		Min.	Typ.	Max.		
Operation Lifetime ¹⁾	t_{OP}	–	–	24000	hours	– ²⁾
ESD susceptibility according to Human Body Model (HBM)	V_{HBM}	–	–	2000	V	Conforming to JESD22-A114-B
ESD susceptibility according to Charged Device Model (CDM)	V_{CDM}	–	–	500	V	Conforming to JESD22-C101-C
Moisture Sensivity Level	MSL	–	–	3	–	Conforming to Jedec J-STD-020C for 240°C

- 1) This lifetime refers only to the time when the device is powered on.

- 2) For worst-case temperature profile equivalent to:
- 1200 hours at $T_j = 125...160^\circ\text{C}$
 - 3600 hours at $T_j = 110...125^\circ\text{C}$
 - 7200 hours at $T_j = 100...110^\circ\text{C}$
 - 11000 hours at $T_j = 25...110^\circ\text{C}$
 - 1000 hours at $T_j = -40...25^\circ\text{C}$

5.5 Revision History

Changes from V0.3 to V0.4D1

- Operating Conditions
 - Added footnote 3 and 4
 - Updated K_{OVAN} and K_{OVAP} max values
 - Added f_{CPU} , f_{LMB} , f_{PCP} , f_{FP1} max for SAK-TC1724F-192F133HL, SAK-TC1724F-192F133HR, SAK-TC1724N-192F80HR, SAK-TC1724N-128F80HR.
 - Updated limits for V_{DD} , V_{DDM} , V_{DDP} .
 - Added I_{IN} , ΣI_{IN}
 - Updated ΣI_{SC_PG}
- Standard Pad Class A1
 - Changed R_{DSON1} to R_{DSONM} , added new condition “PMOS” for 140ohms, added a new condition for “NMOS” with a max value of 100ohms
 - Added R_{DSONW}
 - Changed min value of V_{IHA1} to $0.6 \times V_{DDP}$
 - Changed min value of V_{ILA1} / V_{IHA1} to 0.6
- Standard Pad Class A1+
 - Added HYSA1+
 - Added V_{ILA1+} / V_{IHA1+}
 - Added R_{DSONW} , R_{DSONM}
 - R_{DSON1+} , added new condition “PMOS” for 85ohms, added a new condition for “NMOS” with a max value of 70ohms
 - Changed min value of V_{IHA1+} to $0.6 \times V_{DDP}$
 - Deleted -2000nA to 2000nA limits for I_{OZA1+}
- Standard Pad Class A2
 - Added HYSA2
 - Added R_{DSONW} , R_{DSONM}
 - R_{DSON2} , added new condition “PMOS” for 25ohms, added a new condition for “NMOS” with a max value of 20ohms
 - t_{FA2} , added max 18000ns for CL=20000pF; pinout driver=medium, 65000ns for CL=20000pF; pinout driver=weak
 - t_{RA2} , removed 140ns for CL=150pF; pinout driver=weak
 - t_{RA2} , added 550ns for CL=150pF, pinout driver=weak, 18000ns for CL=20000pF, pinout driver=medium, 65000ns for CL=20000pF, pinout driver=weak
- Standard Pad Class F
 - Added HYSF

Electrical Parameters

- Changed min value of V_{IHF} to $0.6 \times V_{DDP}$
- Added min value of V_{ILF} / V_{IHF} as 0.6
- Added R_{DSONW} , R_{DSONM}
- Deleted note for t_{FF} , t_{RF}
- Standard Pad Class I
 - Changed min value of V_{IHI} to $0.6 \times V_{DDP}$
 - Changed min value of V_{ILI} / V_{IHI} as 0.6
- LVDS Pads
 - Removed input hysteresis F, HYSF
 - Added note “Parallel termination 100 Ohm $\pm 1\%$ ” for t_{FL} , t_{RL} , t_{SET_LVDS}
- Standard Pad Class S
 - Changed max value of V_{IHS} to 3.6
 - Changed min value of V_{ILS} to 2.1
 - Added input leakage current, I_{OZS}
- ADC parameters
 - Changed typ value of C_{AINSW} to 9pF
 - Changed typ value of C_{AINTOT} to 20pF
 - Updated notes for EA_{DNL} , EA_{GAIN} , TUE, EA_{INL} , EA_{OFF}
 - Changed f_{ADCI} to max 20MHz
 - Added f_{ADC} of 110MHz where $ffpimax=110MHz$
 - Added f_{ADC} of 80MHz where $ffpimax=80MHz$
 - Updated f_{ADC} min of 4MHz
 - Added sample time, t_S , 2 to 255 tADCI
 - Added calibration time after reset, t_{CAL} max 4352 cycles
 - Included footnote for TUE for 10-bit and 8-bit conversion
 - Removed I_{AIN7T} (covered by R_{AIN7T})
 - Removed I_{AREF} , added Q_{CONV}
 - Updated notes for I_{OZ2} and I_{OZ3}
 - Updated typ value of 900Ohm for R_{AIN}
- FADC parameters
 - Updated note for EF_{GRAD}
 - Updated note for EF_{OFF}
 - Added f_{FADC} of 110MHz where $ffpimax=110MHz$
 - Added f_{FADC} of 80MHz where $ffpimax=80MHz$
 - Added conversion time, t_C
 - Added analog input voltage range, V_{AINF}
- OSC XTAL parameters
 - Added f_{OSC}
 - Changed max value of V_{IHx} to $V_{DDP}+0.5V$
 - Changed min value of V_{ILx} to $-0.5V$
 - Added typ values for internal load capacitors, C_{L0} to C_{L3} , 2.5pF, 2.5pF, 4pF, 6.5pF
 - Added HYSAX
- Power Supply parameters

Electrical Parameters

- Updated I_{DDP} , I_{DDM} , I_{DDP_FP}
- Added I_{DD} for $f_{CPU}=80\text{MHz}$ for max and realistic patterns
- Updated PD values for max and real patterns, all external, $f_{CPU}=133\text{MHz}$
- Added text to of $f_{CPU}=133\text{MHz}$ to the note for the PD parameter.
- Added PD for $f_{CPU}=80\text{MHz}$ for max and realistic patterns for both all external mode and 5V only with ext.pass device mode
- Current consumption for LVDS pad pairs is updated for all LVDS pads in total
- Deleted the redundant I_{DDP}
- Updated I_{DDP_FP} , I_{DDP_PORST} , I_{DD_PORST}
- Deleted R_{THJA} parameter
- Power Sequencing
 - Added Power Sequencing for 3.3V Supply Only section
- Power, Pad and Reset Timing parameters
 - Removed redundant note for t_{HDH} , t_{HDS}
 - Added text from note “TESTMODE/TRST” to the name of t_{POH} and t_{POS} , deleted note
- EVR Parameters
 - Added I_{PU_VDPG} , V_{IH} and V_{IL} parameters in Pass Device Detector Table
 - Added EVR Parameter Table
- PLL SYSCLK parameters
 - Changed max value for f_{VCO}
 - Added min value of 50us for t_L
 - Included formula 1 and 2
 - Removed note for peak-to-peak noise on pad supply voltage
- PLL ERAY parameters
 - Changed typ value to 250MHz for $f_{PLLBASE}$
 - Added min value of 50us for t_L
 - Removed note for peak-to-peak noise on pad supply voltage
- JTAG Interface parameters
 - Changed to ‘=’ signs in the notes for t_8 , t_9 and t_{10}
- DAP parameters
- Peripheral Timings
 - Removed note for Peripheral Timings “Peripheral timing parameters are not subject to production test. They are verified by design/characterization.”
- MLI Timing
 - Added text for MLI parameters valid for $CL=25\text{pF}$
- MLI Receiver parameters
 - Changed f_{SYS} to 110MHz in footnote 3
- MLI Transmitter parameters
 - Changed t_{13} , TCLK rise time and t_{14} , TCLK fall time to $0.3 \times t_{10}$
- MSC parameters
 - Added text for MSC parameters valid for $CL=25\text{pF}$
 - Added limits for different pad drive strength of t_{45}

- parameters
 - Changed min value of t_{52} to 16.5ns
- ERAY parameters
 - Changed min value of t_{60}
 - Changed max value of $t_{61}-t_{62}$
 - Changed min and max values of t_{63}
 - Changed max value of $t_{64}-t_{65}$
 - Added dT_{xdly} , dR_{xdly}
 - Updated ERAY timing figure
- Flash32 parameters
 - Updated t_{PRD} , t_{PRP}
 - Changed min value of W_{SD} to 50ns x f_{LMB}
 - Updated footnote 3
- Package parameters
 - Added R_{THJCT} , R_{THJCB} , R_{THJCL} for LQFP144
- Package outline
 - Added package outline for LQFP176

Changes from V0.5 to V0.6

- Added max limit for V_{RST5} for 5.0V single supply
- Removed note above MLI Transmitter table
- Updated conditions for t_{FL} and t_{RL} for LVDS pad parameters
- Updated limits for R_{DSONW} and R_{DSONM} for Class A1 pads
- Updated limits for R_{DSONW} and R_{DSONM} and R_{DSON1+} for Class A1+ pads
- Updated limits for R_{DSONW} and R_{DSONM} and R_{DSON2} for Class A2 pads
- Updated limits for R_{DSONW} and R_{DSONM} for Class F pads
- Added footnote 7 to ADC table
- Updated Q_{CONV} of ADC table
- Updated conditions to t_L of PLL Sysclk
- Changed t_{19} of DAP from SR to CC
- Removed condition for V_5
- Added FADC input circuit
- Updated max limit for V_{AGND0} and min limit for V_{AREF0}
- t_{BWG} and t_{BWR} are added to ADC table
- Updated description of t_{CAL}
- Added a placeholder for R_{AIN} , R_{AIN7T} , R_{AREF} , t_S , f_{ADCI} , EA_{DNL} , EA_{INL} , EA_{GAIN} , EA_{OFF} , TUE at a separate ADC table for $V_{DDM}=3.3V$
- Added a placeholder for t_{AWAF} , t_{AWAS} to both ADC tables for $V_{DDM}=5V$ and $V_{DDM}=3.3V$
- Added a placeholder for t_{FWAF} , t_{FWAS} to FADC table for $V_{DDM}=5V$, $V_{DDM}=3.3V$
- Removed limits of gain=8 for EF_{GRAD}
- Added V_{FAREFI} and V_{FAGNDI} parameters
- Updated limit of t_{SF2} to min 120ns
- Typo in Note for I_{V5} at 80MHz is corrected.

Electrical Parameters

- Updated max limit of ΣI_{IN} .
- Added I_{IN} .
- Added Pin Reliability in Overload subchapter.
- Removed sentence “Exposure to conditions within the maximum ratings will not affect device reliability.” Replaced with the Pin Reliability in Overload subchapter.
- Added definition of driver strength settings, updated footnote 4 for ERAY Interface Timing
- Updated max limits of Flash parameters t_{PRD} , t_{PRP}
- Updated representation of I_{DDP}
- Updated limits of I_{DD_PORST} to max 110mA
- Updated limits of I_{DDP_PORST} to max 6mA
- Updated limits of I_{DD} for real pattern, $f_{CPU}=133\text{MHz}$, to max 212mA
- Added new parameter I_{DDSUM}
- Updated max limit of I_{DDM} to 32mA
- Updated TC1724 I_{V5} for max and real patterns, with and without ERAY, $f_{CPU}=133\text{MHz}$
- Updated TC1724 I_{V5} for max pattern, $f_{CPU}=80\text{MHz}$
- Updated PD for real pattern, $f_{CPU}=133\text{MHz}$, all external supplies.
- Updated TC1724 PD for max and real patterns, with and without ERAY, $f_{CPU}=133\text{MHz}$, 5V only with external pass device.
- Updated TC1724 PD for max and real patterns, $f_{CPU}=80\text{MHz}$, 5V only without external pass device.
- Updated limit for R_{DSON2} of A2 pad, P_MOS
- Removed V_{IH} for Pass Device Detector
- Updated limits for V_{IL} of Pass Device Detector
- Updated limits and test conditions for ΔV_{LREG33} and ΔV_{LREG33}
- Updated test condition for 5.0V single supply ΔV_{LREG13}
- Updated limits and test condition for 5.0V single supply ΔV_{LREG13}
- Corrected typ and max limits for C_{OUT33} and C_{OUT13}
- Added limit and test condition for 3.3V single supply ΔV_{LREG13} and ΔV_{LREG13}
- Application reset boot time limits are updated
- Added min limit for I_{OZS}
- Added a new parameter V_{ILSD}
- Updated limits for t_{BP} , STT
- Removed typical text from load of Peripheral Timing sections.
- Limits for EF_{GRAD} with Gain=4 is changed to TBD
- Min limit for V_{DDM} is changed to TBD
- Added EF_{REFI}
- Added a placeholder for R_{FAIN} , EF_{DNL} , EF_{INL} , EF_{GRAD} , EF_{OFF} at a separate ADC table for $V_{DDM}=3.3\text{V}$
- Added max and typ limits for R_{RAIN} for $V_{DDM}=3.3\text{V}$
- Updated limits of P_D for real pattern, $f_{CPU}=80\text{MHz}$, to max 669mW
- Added new variant SAK-TC1724F-192F80HR
- Updated text for Note column of N_E

Electrical Parameters

- Corrected typo for Class D pads in PN-Junction Characteristics for positive/negative overload tables
- Updated limits of I_{DD} for max pattern, $f_{CPU}=133\text{MHz}$, to max 310mA
- Updated limits of I_{DD} for max pattern, $f_{CPU}=80\text{MHz}$, to max 248mA
- Updated limits of P_D for max pattern, $f_{CPU}=133\text{MHz}$, to max 902mA
- Updated limits of I_{DD} for max pattern, $f_{CPU}=80\text{MHz}$, to max 810mA
- Corrected typo for C_{OUT13}
- Updated load jump current for C_{OUT33} and C_{OUT13} for $f_{CPU}=80\text{MHz}$
- Changed min to typ value for C_{IN5}

Changes from V0.6 to V0.7

- Name of package is updated

Changes from V0.7 to V0.8

- Absolute maximum rating section for is updated for V_{DDP} , V_{IN} , V_{AIN} , V_{AREFO} , V_{AINF}
- A footnote is added to t_{ERD}
- A note is added, updated pad supply levels in Pin Reliability in Overload section
- Updated min limit for t_{17} of MLI
- Added a footnote to I_{DDP}
- Included text to power sequencing sections for setting of P0.4 and P0.5.
- Added limits for EF_{DNL} for Gain= 4, 8
- Changed STT to t_{EVR} , updated Power, Pad and Reset Timing figure
- Changed min limit of t_L for PLL_ERAY timing
- Changed min limit of t_L for PLL_Sysclk timing
- Removed I_{PU_VDPG} for $V_{DD5} \geq 2.97\text{V}$, $V_{DD5} \leq 3.63\text{V}$
- Updated limit and test condition for C_{OUT33} , C_{OUT13}
- Updated limit for C_{IN5}
- Updated limit and test condition for $\Delta V_{LOREG33}$
- Removed $PSRR_{33}$, $PSRR_{13}$
- Updated test condition for $\Delta V_{LOREG13}$
- Updated limit and test condition for $\Delta V_{LIREG13}$
- Updated min limit for MSC t45, strong sharp setting, CMOS mode
- Added ΔV_{OUT33} , ΔV_{OUT13} parameters
- Updated first sentence for Chapter 5.3
- Added text for MLI and SSC parameters for validity of strong driver medium edge only
- Updated description for t_{52} and t_{53}
- Changed SSC parameters from CC to SR for t_{56} , t_{57} , t_{58} , and t_{59}
- Changed min to max limit for EVR Supply ramp-up parameter
- Updated min limit for I_{PU_VDPG}

Changes from V0.8 to V1.0

- Added limits for EF_{GRAD} for Gain= 4, 8
- Added limits for EF_{REFI}

Electrical Parameters

- Updated V_{FAGNDI} , V_{FAREFI} , changed from SR to CC
- A footnote is added for V_{FAREFI}
- Updated limit for C_{OUT13}
- Updated limit for C_{IN5}
- Added min limit for V_5
- Updated limits for f_{ADCI} , t_{BWG} , t_{BWR} , t_{AWAF} , t_{AWAS} , t_{FWAF} , t_{FWAS}
- Updated limits for ADC table, $V_{DDM}=3.3V$, f_{ADCI} , t_{BWG} , t_{BWR} , t_{AWAF} , t_{AWAS} , t_{FWAF} , t_{FWAS} , R_{AIN7T} , EA_{DNL} , EA_{GAIN} , EA_{INL} , EA_{OFF} , TUE , Q_{CONV}
- Corrected typo in test condition for R_{DSON}
- Removed footnote 2 from ΣI_{SC_D}
- Added footnote 3 to V_{DDM}
- Corrected typo for Class F in Table 14 and Table 15
- Updated max limit for ADC parameter t_S
- Added footnote 2 for t_9 of JTAG parameter
- Changed t_{26} , t_{27} from CC to SR
- Updated max limit for ADC parameter V_{AIN}
- Added footnote 5 to t_{59}
- Added t_{POR_APP} parameter of Reset Timing parameters
- Updated max limit for ERAY parameter t_{60}

Changes from V1.0 to V1.1

- Updated limits for ADC table, $V_{DDM}=3.3V$, f_{ADCI} , t_{BWG} , t_{BWR} , t_{AWAF} , t_{AWAS} , R_{AIN7T} , EA_{DNL} , EA_{GAIN} , EA_{INL} , EA_{OFF} , TUE , Q_{CONV}
- Added new marking options for TC1724
- Updated description for t_{CAL}
- Added a footnote to Q_{CONV}

Changes from V1.1 to V1.2

- change t_{48} from 100ns to 200ns in table 29
- change t_{49} from 100ns to 200ns in table 29
- extend K_{OVAN} condition from $I_{OV} \leq 0$ mA; $I_{OV} \geq -1$ mA to $I_{OV} \leq 0$ mA; $I_{OV} \geq -2$ mA
- clarify leakage definition for A1 and I pads for $150^\circ C < T_J \leq 160^\circ C$
- change V_{ILS} from 2.1V to 1.9V in table 25
- change t_{56} from $1/f_{FPI}$ to $1/f_{FPI} + 1$ in table 30
- change R_{AIN} from 4500 Ohm to 9000 Ohm in table 15
- remove the following product options:
 - SAK-TC1724N-192F133HL
 - SAK-TC1724F-128F133HL
 - SAK-TC1724F-128F133HR
 - SAK-TC1724N-128F133HL
 - SAK-TC1724N-128F133HR
 - SAK-TC1724N-128F80HL
 - SAK-TC1724N-128F80HR
 - SAK-TC1724N-192F133HL

Electrical Parameters

- SAK-TC1724F-128F80HR
- shift the product SAK-TC1724N-192F133HR from step AB to AC
- add for products SAK-TC1724F-192F133HR and SAK-TC1724N-192F80HR step AC



SKYTECH

تهیه و توزیع قطعات الکترونیک



SKYTECH

www.infineon.com تهيه وتوزيع قطعات الكترونيك

Mouser Electronics

Authorized Distributor

Click to View Pricing, Inventory, Delivery & Lifecycle Information:

[Infineon:](#)

[TC1724N192F80HRACKXUMA2](#)

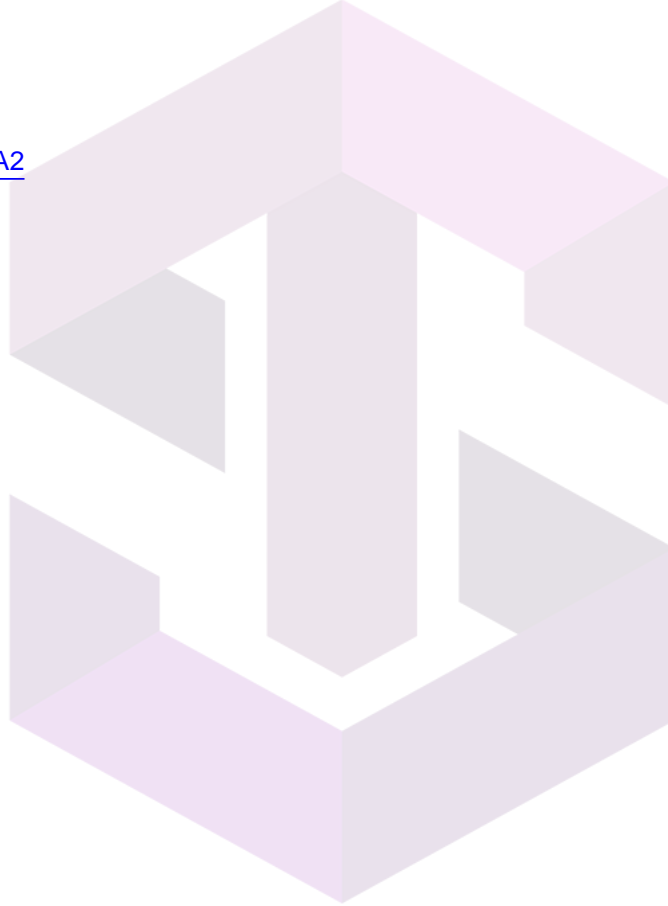

SKYTECH

تهیه و توزیع قطعات الکترونیک